

Scout® *Pro* Balance Instruction Manual



TABLE OF CONTENTS

1. INTRODUCTION	EN-3
Safety Precautions	EN-3
2. INSTALLATION	EN-3
Unpacking	EN-3
Installing Components	EN-4
Releasing the Shipping Lock	EN-4
Platform Installation	EN-4
Draft Shield Installation (120g Model)	EN-4
Security Bracket	EN-4
Selecting the Location	EN-5
Connecting Power	EN-5
Battery Installation	EN-5
AC Adapter Installation	EN-5
3. OPERATION	EN-6
Overview of Controls and Display Functions	EN-6
Button Functions	EN-8
Symbols Used for Operation of the Balance	EN-9
Turning the Balance On	EN-9
Turning the Balance OFF	EN-10
Navigating the Menus	EN-10
Menu Structure	EN-11
Entering the Menus	EN-11
Accepting/Bypassing an Individual Menu Item	EN-11
Entering the .S.E.T.U.P. Menu	EN-12
Turning Display Hold, Totalize or Specific Gravity Mode On	EN-13
Exiting the .S.E.T.U.P. Menu	EN-13
Entering the .U.N.I.T. Menu	EN-13
Parts Counting	EN-14

TABLE OF CONTENTS (Cont.)

Calibration	EN-14
Span Calibration	EN-14
Linearity Calibration	EN-15
Applications	EN-16
Weighing	EN-16
Weighing with Tare	EN-16
Parts Counting	EN-17
Percent Weighing	EN-18
Establishing a New Reference Weight	EN-19
Exiting Percent Weighing	EN-19
Display Hold	EN-19
Exiting Display Hold	EN-20
Totalize	EN-20
Clear Exit Totalize	EN-21
Specific Gravity	EN-21
Clear Exit Specific Gravity	EN-22
Additional Features	EN-22
Weigh Below	EN-22
Lock Switch	EN-23
4. MAINTENANCE	EN-24
Cleaning	EN-24
Troubleshooting	EN-24
Error Codes List	EN-25
Accessories	EN-26
5. TECHNICAL DATA	EN-27
Specifications	EN-27
Compliance	EN-28
Warranty	EN-29

1. INTRODUCTION

The Scout *Pro* offers parts counting with auto optimization, display hold, totalize, % weighing and specific gravity mode. Models are available with ranges from 120g to 6000g.

Scout *Pro* standard features include:

- Battery or AC operation (AC adapter included)
- Density/Specific Gravity determination (certain models)
- Integral security bracket
- Programmable auto shut-off
- Span calibration masses included on certain models
- Optional USB or RS232 interface available

Safety Precautions

Please follow the safety precautions as listed:

CAUTION:



- Do not operate the balance around corrosive fumes.
- Use only the adapter provided with the balance.
- Do not try to service the Scout *Pro* balance.
- Before plugging in the balance, make sure that the voltage rating of the power adapter and the AC supply voltage match.

2. INSTALLATION

Unpacking

Your Scout *Pro* package contains:

- Scout *Pro* Balance
- Warranty card
- AC Power Adapter
- Platform
- Instruction Manual
- Calibration Masses (on certain models)
- Draft shield (120g Model only)

Store the packaging material for future transport.

Installing Components

Releasing the Shipping Lock

On top of the balance, turn the pointer 90 degrees counter-clockwise to unlock.

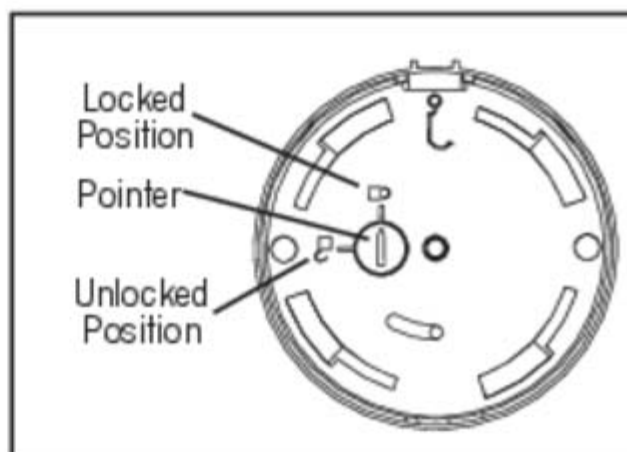

Releasing the Shipping lock.

Platform Installation

Balances with a rectangular platform are placed into the subplatform as shown and rotated counter-clockwise until it locks. Round platforms are placed straight down on subplatform.



Platform Installations.

Draft Shield Installation (120g Model)

Position the keyed draft shield on top of the balance and rotate it until it faces forward.

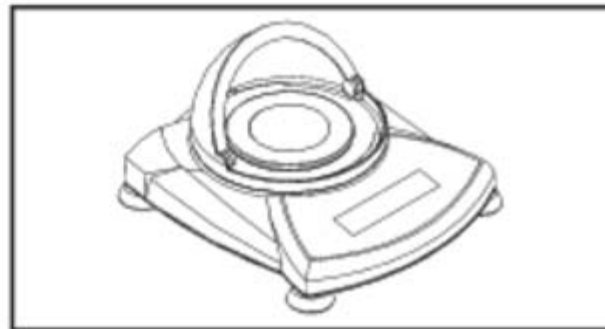
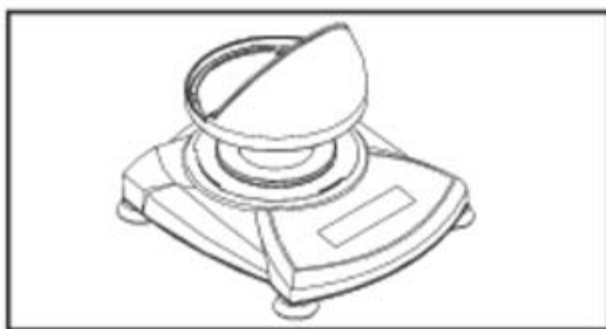

Installing Draft Shield.

Security Bracket

A security bracket is provided at the rear of the balance allowing the balance to be secured by an optional cable and lock accessory.

Selecting the Location

For best performance, the Scout *Pro* balance should be used in a clean, stable environment. Do not use the balance in environments with excessive drafts, with rapid temperature changes, near magnetic fields or near equipment that generates magnetic fields, or vibrations.

Connecting Power

Battery Installation

Install the Four "AA" batteries with polarity as shown in the battery compartment.

AC Adapter Installation

Plug the AC adapter into the jack at the rear of balance.

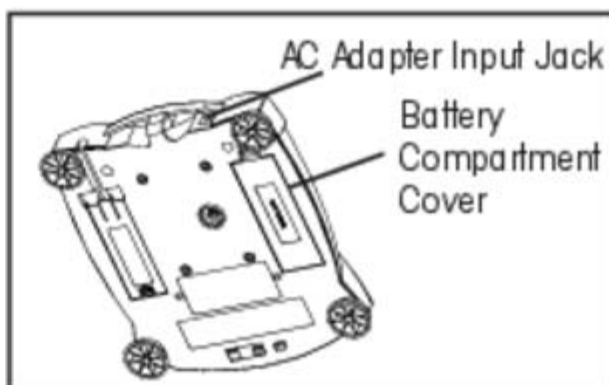

Battery and AC Power Connections

3. OPERATION

Overview of Controls and Display Functions

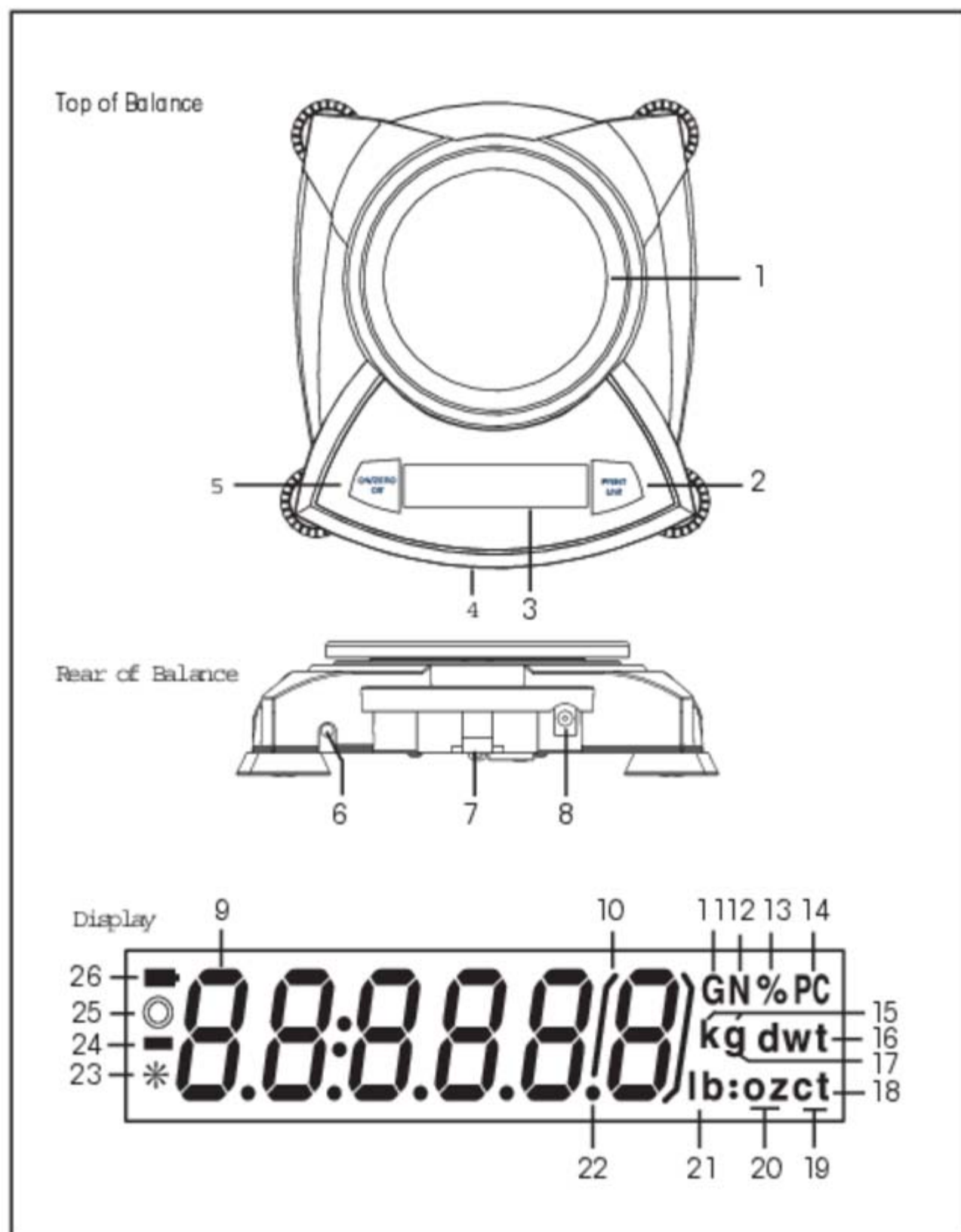

No.	Designation	Function
1.	Platform	Weighing platform, either round or rectangular.
2.	PRINT Unit button	Prints data, scrolls through units, steps through menu options.
3.	Display	LCD display with icons.
4.	Lockswitch	Locks certain menu functions, located under balance.
5.	ON/ZERO Off button*	On/Off, Zero, enters menu, accepts menu settings.
6.	USB or RS232 port	Optional kit for either RS232 or operation USB.
7.	Security Bracket	Part of balance for optional external cable and lock.
8.	Power Input Jack	Connector for AC adapter.
9.	7-segment LCD	Part of 6-digit LCD display.
10.	Brackets	Auxiliary indication.
11.	G	Indicates specific gravity
12.	N	Indicates Newtons.
13.	%	Indicates percent weighing.
14.	PC	Indicates pieces during parts counting.
15.	kg	Indicates weight in kilograms.
16.	dwt	(not used)
17.	g	Indicates weight in grams.
18/20.	oz t	(not used)
18.	t	Indicates totalize mode
19.	ct	(not used)
20.	oz	Indicates weight in ounces.
21/20.	lb:oz	(not used)
21.	lb	Indicates weight in pounds. (certain models)
22.	•	Decimal point.
23	*	Stability indicator, indicates stable weight and Display Hold when flashing.
24.	-	Negative sign.
25.	○	(not used)
26.		Battery indicator flashes when battery is down to

Note:* This button is configured either as "ON/ZERO Off" or "ON / O/T Off" depending on country. There is no difference in functionality. In this manual, "ON/ZERO Off" is used as example.

Button Functions

Two switches provide the necessary functions to access a given menu, select a function and to turn it on or off. Functions are listed as follows:



ON/ZERO Off Button

Primary Function (ON/ZERO)- Turns on balance. If balance is on, zeros the display.

Secondary Function (Off)- Turns balance off, **OFF** will be displayed after button is held for 3 seconds. In Display Hold or Totalize mode, a long press exits the mode without turning the balance off.

Menu Function- An extended long press (>5 seconds) during power up will cause the balance to enter the Menu mode. A short press is used to accept a setting on a display.

PRINT Unit Button









Primary Function (PRINT)- Sends print command to interface port. If Display Hold or Totalize mode is active, a short press will enter that mode.

Secondary Function (Unit)- Press and hold scrolls through units. Release on desired unit.

Menu Function- Will bypass setting shown on display.

Symbols Used for Operation of the Balance

Symbols are used to simplify the setup and operation of the balance. A description of each symbol follows:

	Press	
		The clock symbols adjacent to the finger symbol indicates the length of time to press a button.
	1 second momentary press.	
	3 second extended press.	
	5 second extended press.	
		Panel control buttons used to initiate actions.
		Displays are shown as they actually appear on the balance. A model with 200g capacity was used for the displays shown in this manual.
•••		Indicates scrolling to a final display. The first and last displays are shown.
		Indicates advances to next display.

Turning the Balance On

  →  ... 

Turning the Balance Off

  →  → 

Navigating the Menus

Menu Structure

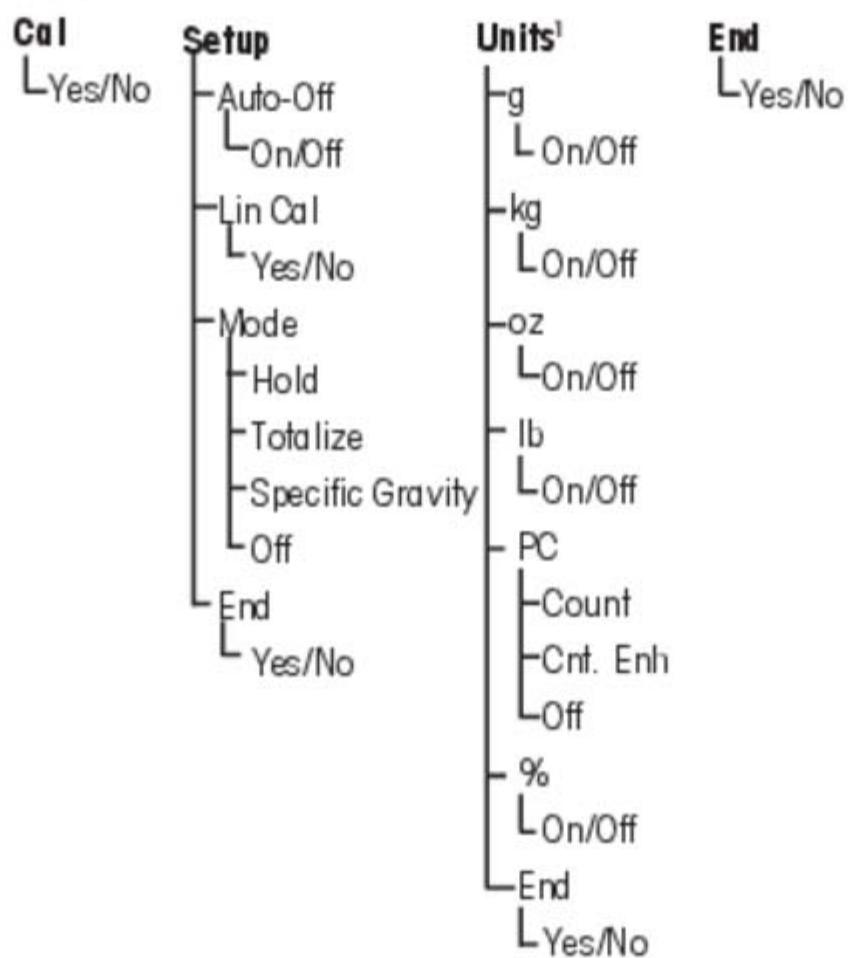

NOTES:

1. Refer to specification table for available units.

Entering the Menu

There are four main menus in the balance: **.C.A.L.**, **.S.E.T.U.P.**, **.U.N.I.T.S.** and **.E.N.D.**

Start with the balance off and the Lock Switch off (see page 23).

The sequence is shown below.

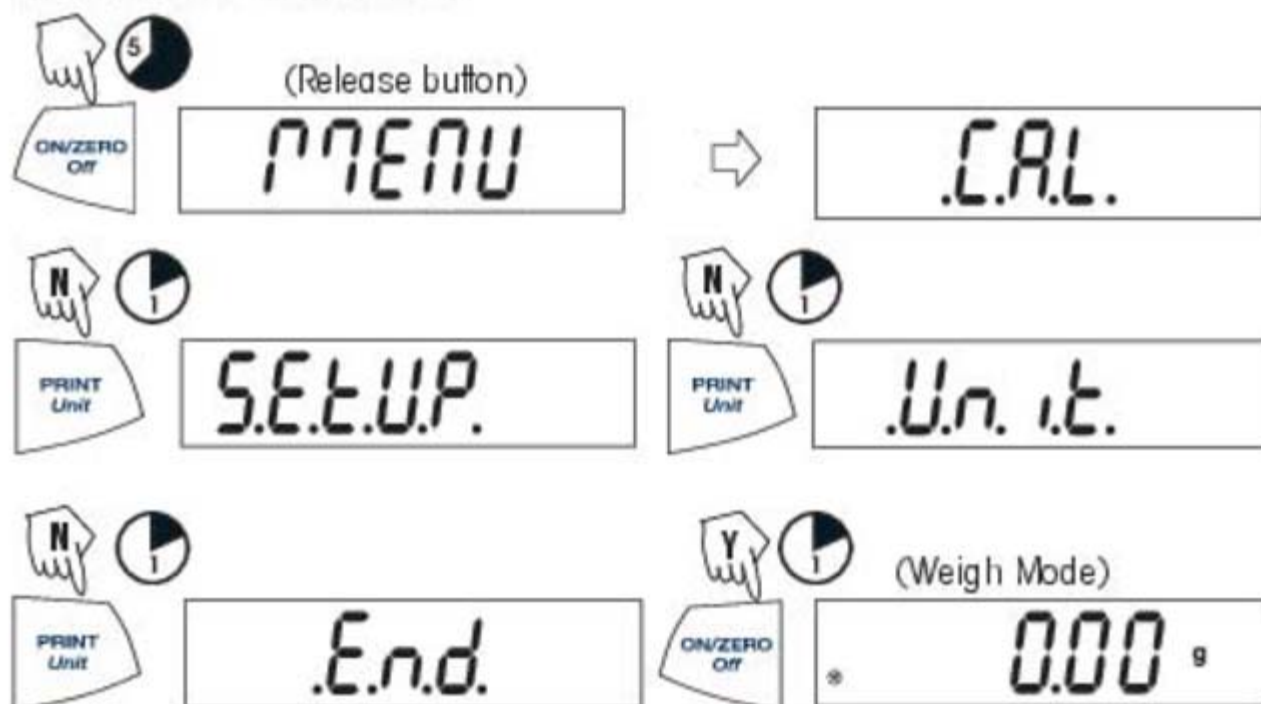

Accepting / Bypassing an Individual Menu Item

Start with menu item displayed.

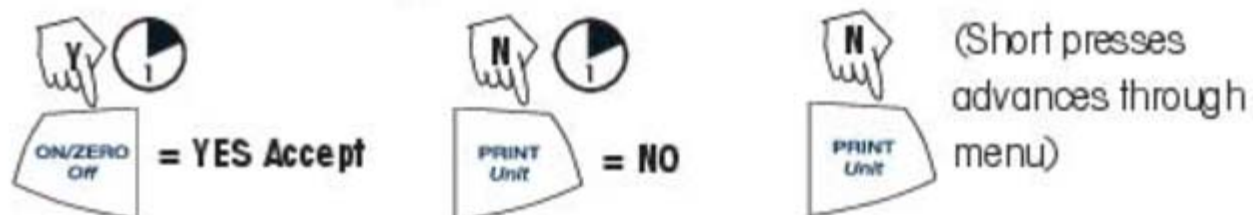

Entering the .S.E.T.U.P. Menu

The **.S.E.T.U.P.** menu contains Auto-Off, Linearity Calibration, Mode (Display Hold, Totalize, Specific Gravity) and END. Auto-Off can be turned on or off. Display Hold, and Totalize require entering the Mode submenu.

Starting from the **.C.A.L.** menu.

The diagram illustrates the sequence of screen displays and button presses to reach the .S.E.T.U.P. menu and configure Auto-Off:

- Step 1:** Press **Y** (Yes) to enter the **(First menu)** displaying **A-OFF**. A **PRINT Unit** button is shown to the left.
- Step 2:** Press **ON/ZERO Off** to change the display to **OFF**. A **PRINT Unit** button is shown to the left.
- Step 3:** Press **ON/ZERO Off** to change the display to **On**. A **PRINT Unit** button is shown to the left.
- Step 4:** Press **Y** (Yes) to exit and save. The display returns to **A-OFF**. A **PRINT Unit** button is shown to the left.

Select ON or OFF for Auto-Off. To enter Display Hold, Totalize or Specific Gravity, you must first enter the Mode sub-menu.

Turning Display Hold, Totalize or Specific Gravity Mode On

NOTE: Only one mode can be active at one time.

Start at the **.S.E.T.U.P.** menu.

The diagram illustrates the sequence of screen displays and button presses to enter the Mode submenu and select a mode:

- Step 1:** Press **N** (No) repeatedly to enter the **MODE** submenu. A **PRINT Unit** button is shown to the left.
- Step 2:** Press **ON/ZERO Off** to select **Hold**. A **PRINT Unit** button is shown to the left.
- Step 3:** Press **ON/ZERO Off** to select **TOTAL**. A **PRINT Unit** button is shown to the left.
- Step 4:** Press **ON/ZERO Off** to select **SPEC.Gr**. A **PRINT Unit** button is shown to the left.
- Step 5:** Press **ON/ZERO Off** to select **OFF**. A **PRINT Unit** button is shown to the left.

Press YES to desired mode, then continue.

Exiting the **.S.E.T.U.P.** Menu

Select ON/OFF or YES/NO to desired menu items, proceed to **.E.N.D.** menu.



Entering the **.U.N.I.T.** Menu

The **.U.N.I.T.** menu contains units of measure, PC (parts counting), % weighing and END. Units vary with the model type. Determine which units are to be turned on or off.

Start in the **.U.N.I.T.** menu. Select either ON or OFF for each unit.

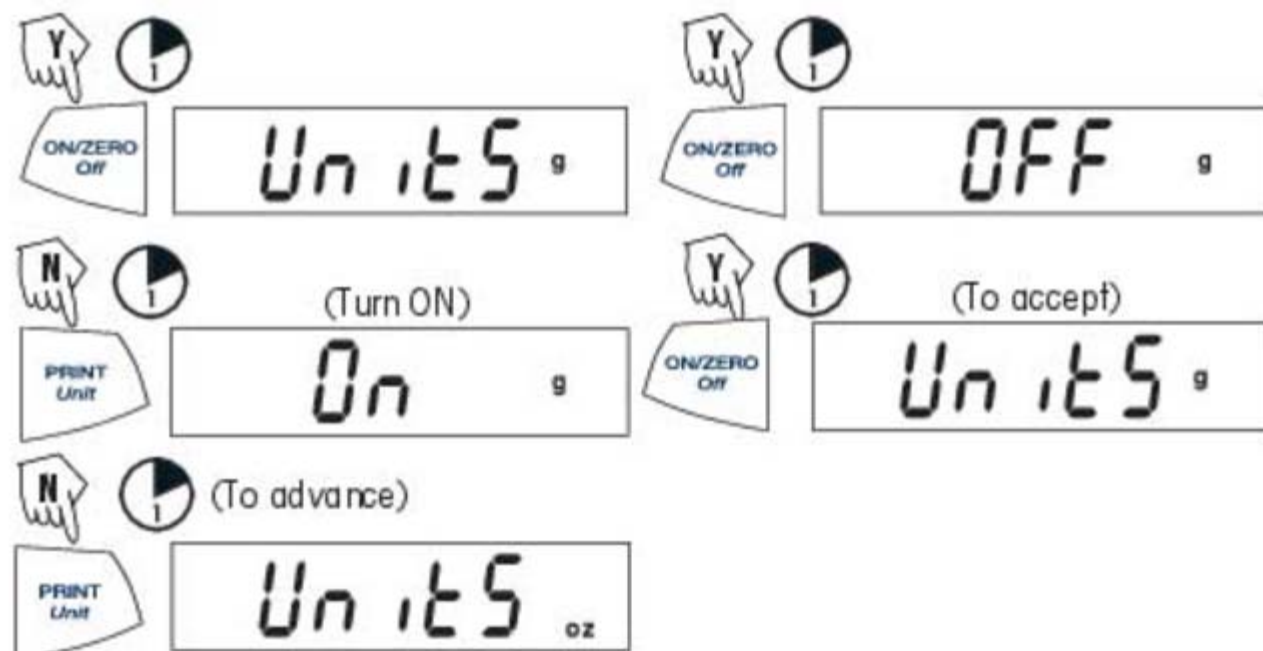

NOTE: Repeated presses of **PRINT Unit** button will go through all units, you then may select ON or OFF. Parts Counting is slightly different.

Parts Counting

Two types of counting modes are available, standard or enhanced.



Exiting the .U.N.I.T. Menu

Use the same procedure as Exiting the .S.E.T.U.P. Menu.

Calibration

Span Calibration

Span calibration uses two calibration points, zero and a specified calibration weight. Before beginning calibration, make sure the Lock Switch is off. Clear the platform.

NOTE: Value of calibration mass depends on capacity of balance. After calibration, the balance returns to the currently selected weigh mode.

Start with the balance OFF.

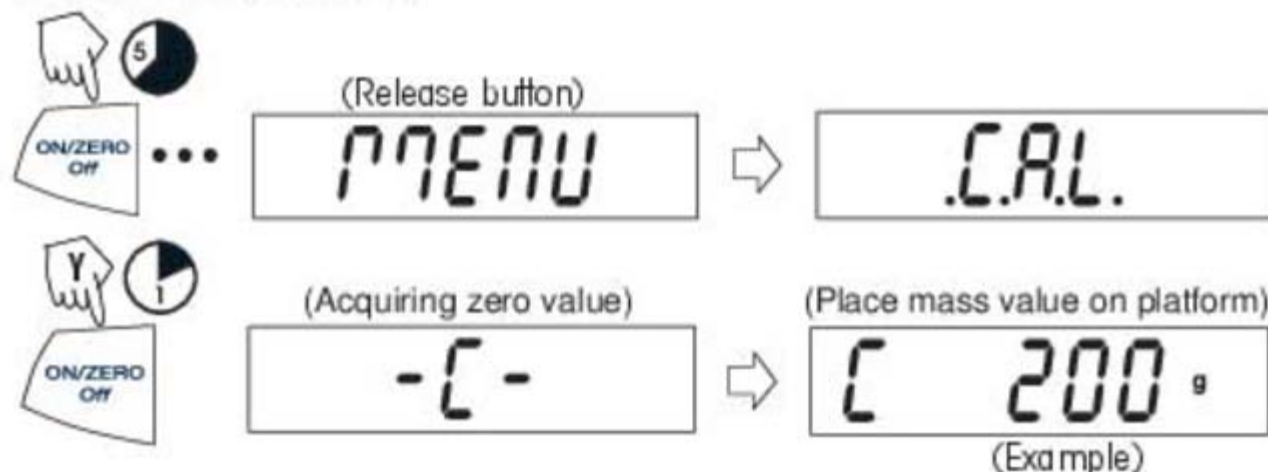

Span Calibration (Cont.)

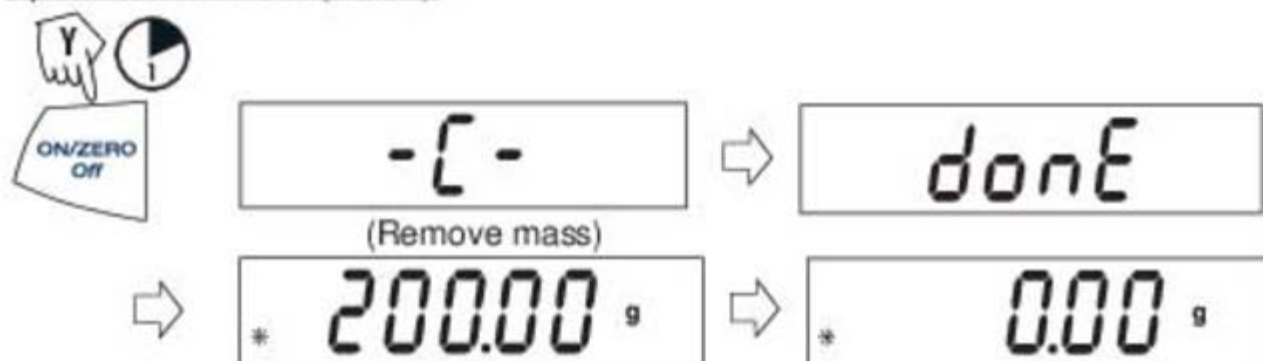

Linearity Calibration

Linearity calibration uses three calibration points; zero, mid-scale and full scale. Lin Cal must be selected and set to YES in the **S.E.T.U.P.** Menu. Before beginning calibration, make sure the menu Lock Switch is off. Clear the platform. Start with the balance OFF.

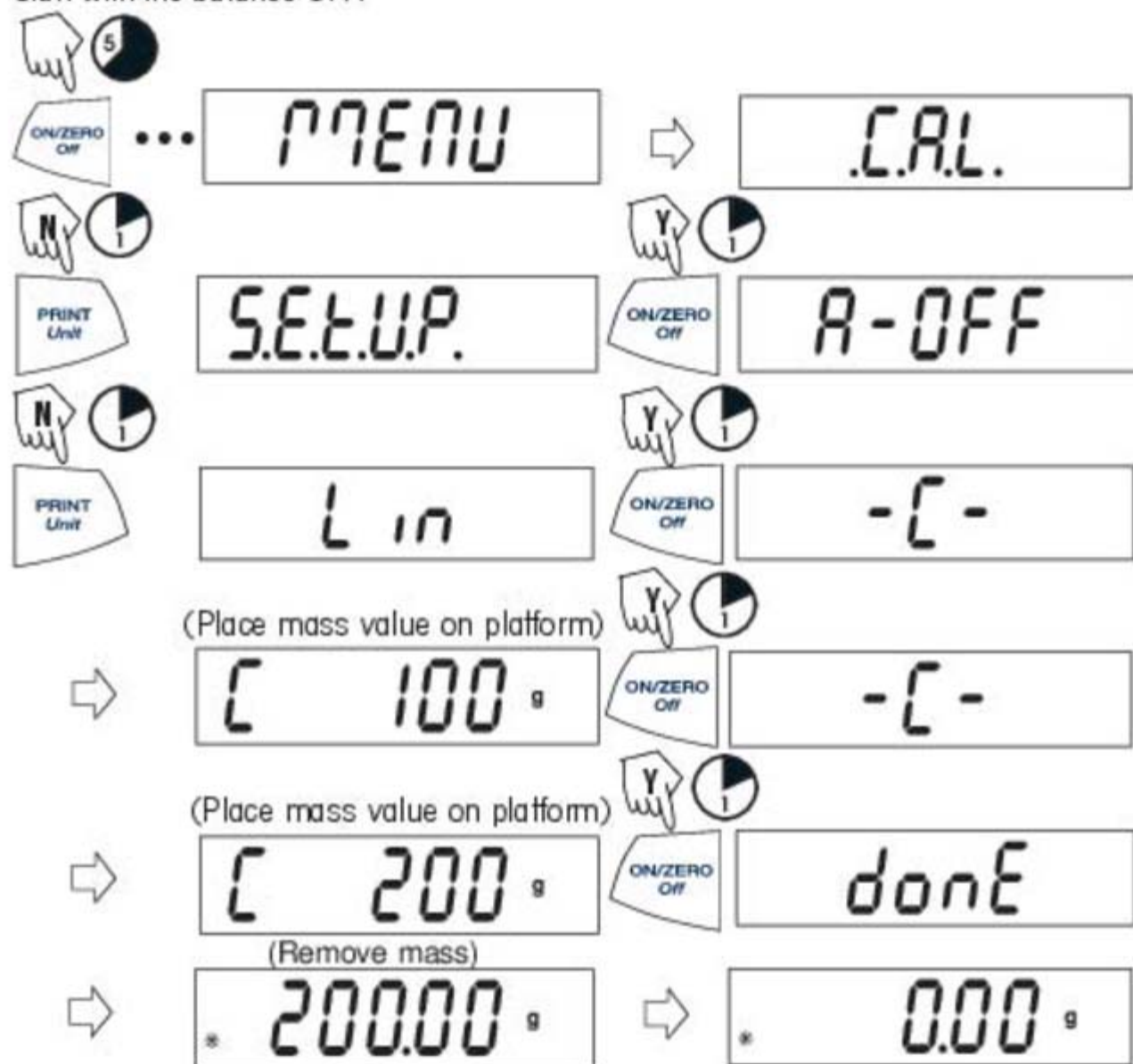

Applications

Scout Pro applications include: Weighing, Parts Counting, Percent Weighing, Display Hold, Totalize and Specific Gravity.

Weighing

Start with the balance on.



Weighing with Tare

Taring zeros the container weight. With the balance on, place an empty container on the platform. (Display example indicates a container weight of 23g.)

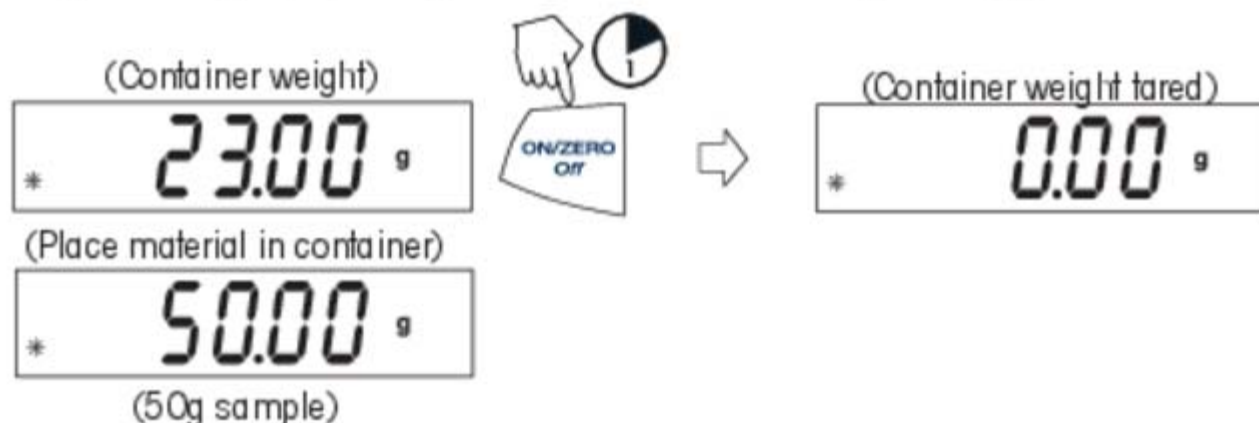

NOTE: Removing the container and material from the platform will cause the balance to display the container's weight as a negative number. The tared weight remains until **ON/ZERO Off** button is pressed again or the balance is turned off.

(Remove container with material)



Parts Counting

Parts Counting is *enabled only* when PC is turned ON in the **.U.N.I.T.** menu. In parts counting mode, there are two modes of parts counting, normal and enhanced. In normal parts counting, the balance determines the quantity based on the average weight of the parts in the original reference quantity. In the enhanced mode, additional parts can be added to the platform equal to or less than the original number. The additional reference quantity produces a more accurate average part weight.

Standard Parts Counting

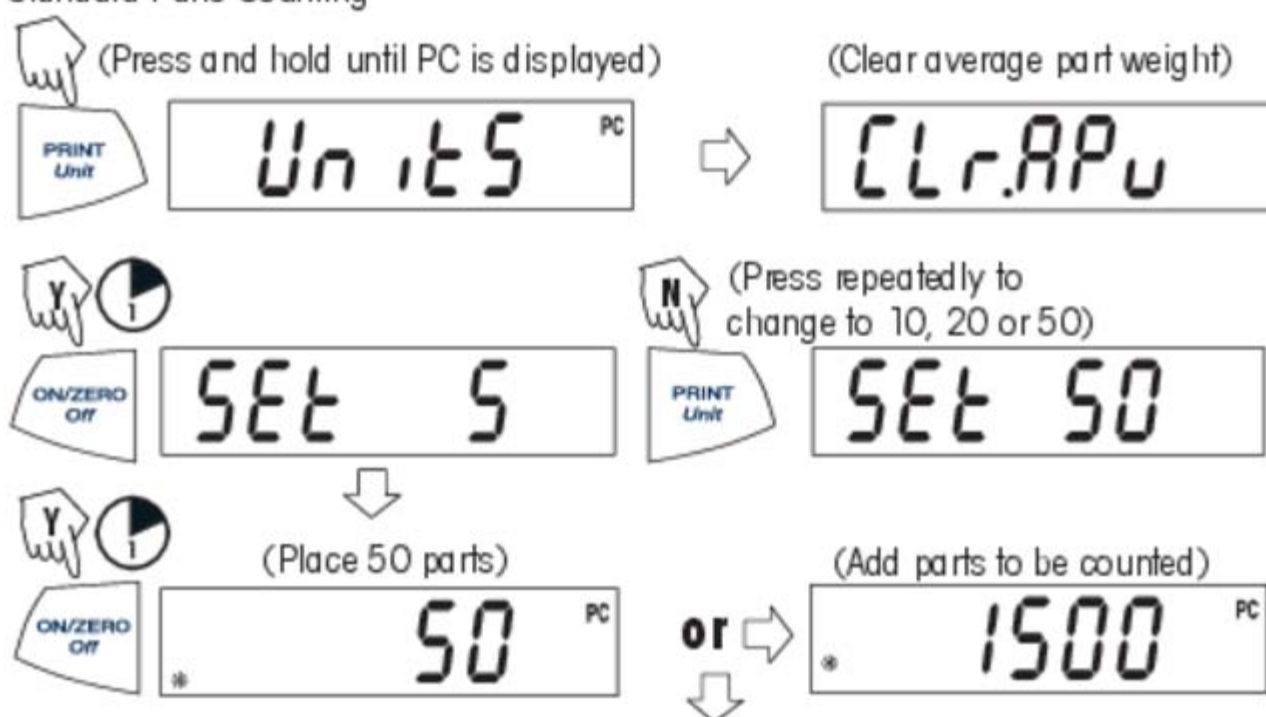

Enhanced Parts Counting

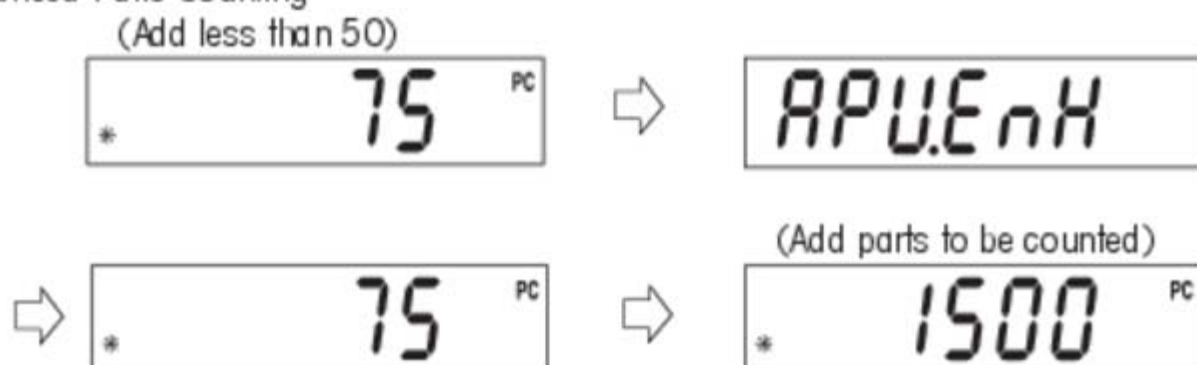

NOTE: The preceding procedure for enhanced counting can be repeated as many times as necessary providing the quantity added is less than the original entry.

Parts Counting (Cont.)

To count different parts, press and hold, until PC reappears, release Unit button.

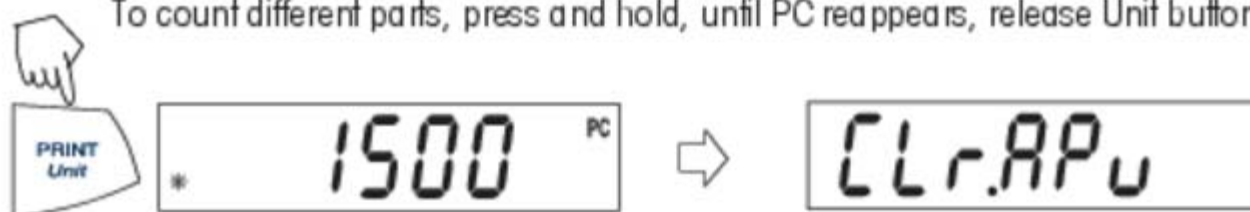

Percent Weighing

Percent Weighing is *enabled only* when Percent is turned ON in the **.U.N.I.T.** menu. Percent weighing permits placing a reference weight on the balance, then viewing other loads as a percentage of the reference. The reference weight equals 100%. Start in the weighing mode and zero the display.

(Press and hold until % is displayed)



(Example)
(Remove reference weight)



(Place load on the platform, display indicates percentage of reference weight.)

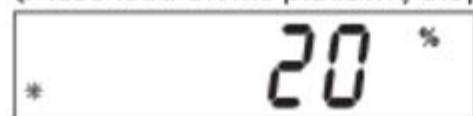

Establishing a New Reference Weight

 Press and hold until % on the display reappears, then release.

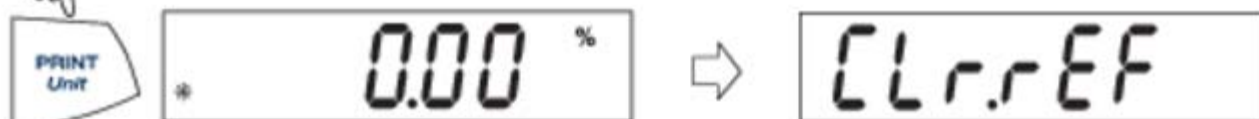

Repeat above procedure for new a reference weight.

Exiting Percent Weighing

 Press and hold until desired unit is displayed.



Display-Hold

Display-Hold is *enabled only* when Hold is turned ON in the Mode submenu in the **.S.E.T.U.P.** menu. Display-Hold mode captures and stores the highest stable value. When displayed, the stable icon will blink. **NOTE:** Units cannot be changed when in Display-Hold mode.

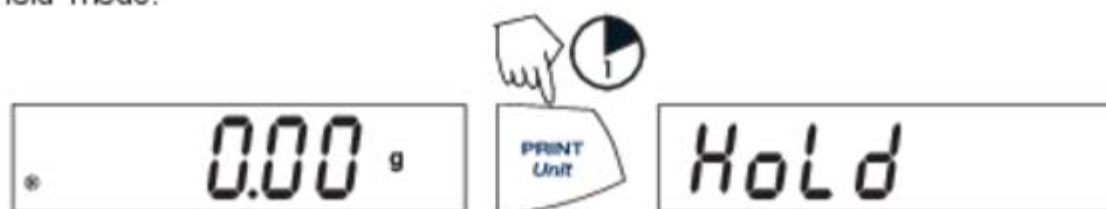

Place item(s) on platform.



Exiting Display Hold



To return to display hold, repeat above procedure.

Totalize

Totalize is *enabled only* when Total is turned ON in the Mode submenu in the **S.E.T.U.P.** menu. Totalize allows storage of a series of weight measurements. Totalize mode has been initiated when **T** and the current unit, i.e. (g) is displayed. When totalized weight is shown, the **T** indicator will blink. **NOTE:** Units cannot be changed when in Display-Hold mode.

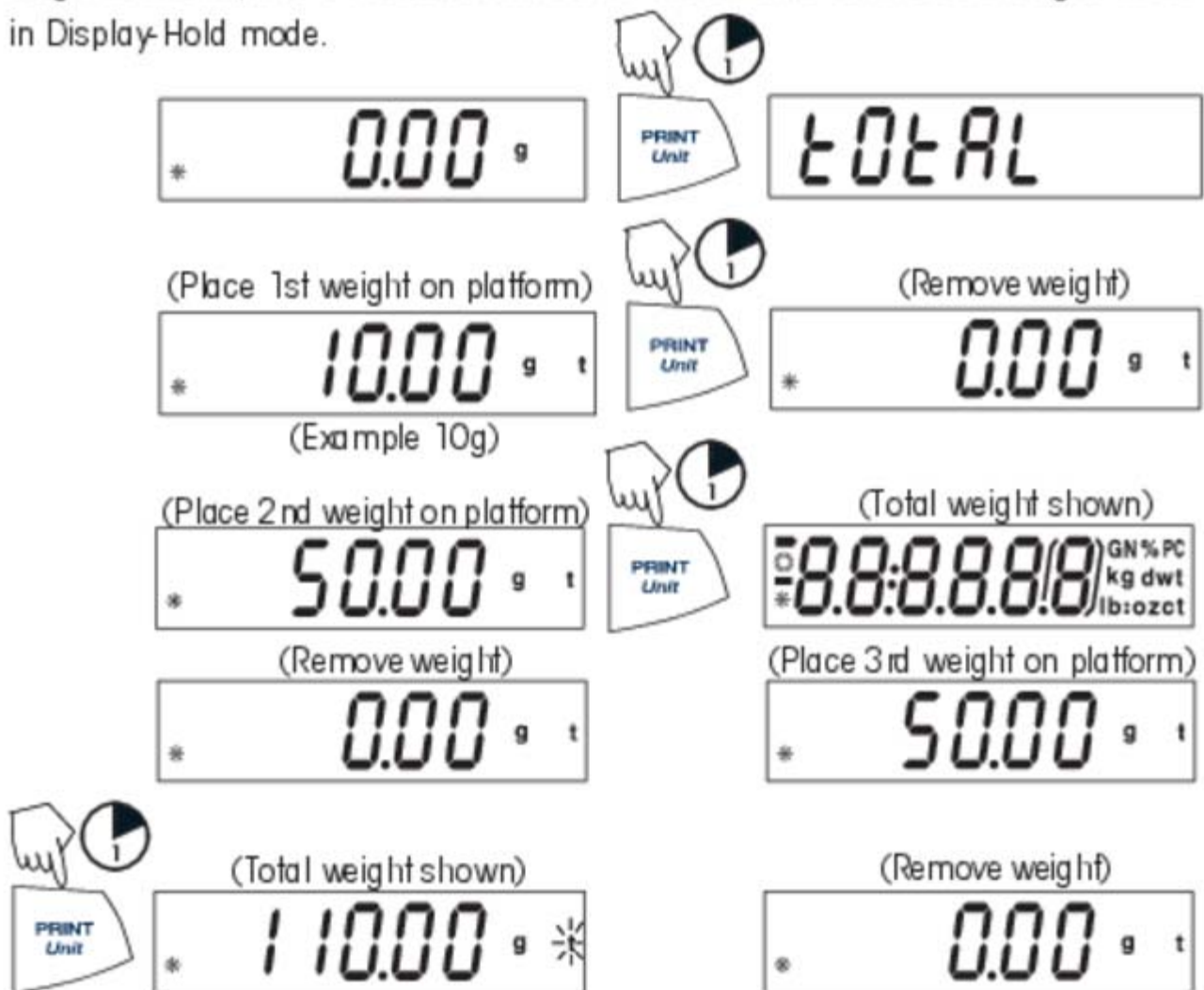

Total weight will remain on the display until weight is removed. The total weight remains in memory. Total is limited to 999999.

Clear/Exit Totalize

Performing this next step will erase all totalized memory.



Specific Gravity with Accessory Kit

Specific gravity is *enabled only* when SPEC.Gr is turned ON in the Mode submenu in the **.S.E.T.U.P.** menu. The Specific Gravity mode allows calculating the specific gravity of a sample. **SPEC.GR mode must be turned ON before removing platform and installing hook.** Prepare the balance as shown. Remove the balance platform, insert the hook and install the beaker stand. Beaker is not supplied.

The sample is weighed in air suspended from the hook and then weighed in water. The formula is

$$\frac{\text{dry wt}}{\text{dry wt} - \text{wet wt}}$$

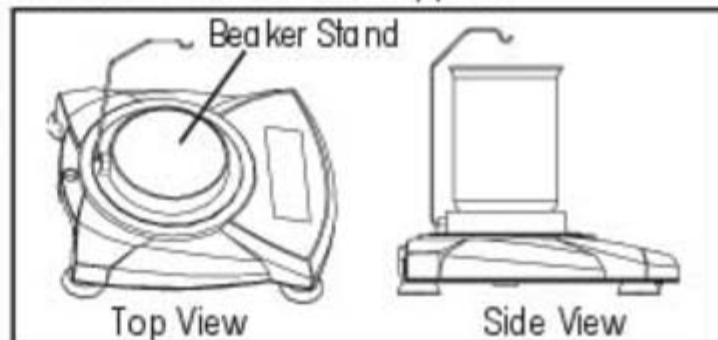

Specific Gravity Setups

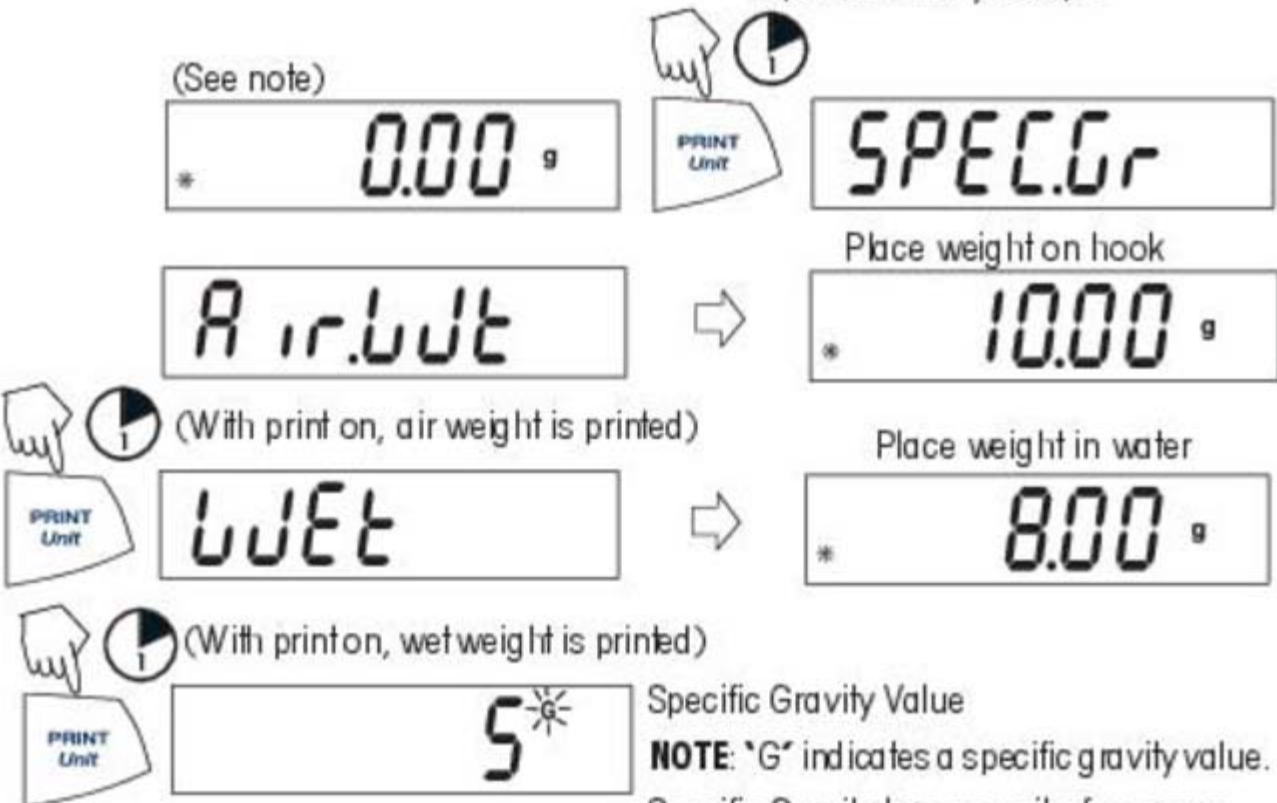

Clear/Exit Specific Gravity



Additional Features

Weigh Below

Scout Pro permits below balance weighing for applications such as specific gravity/density determination. The balance is normally elevated, supported on all feet and leveled. A fine wire is attached to the built-in hook at the bottom of the balance (see illustration).

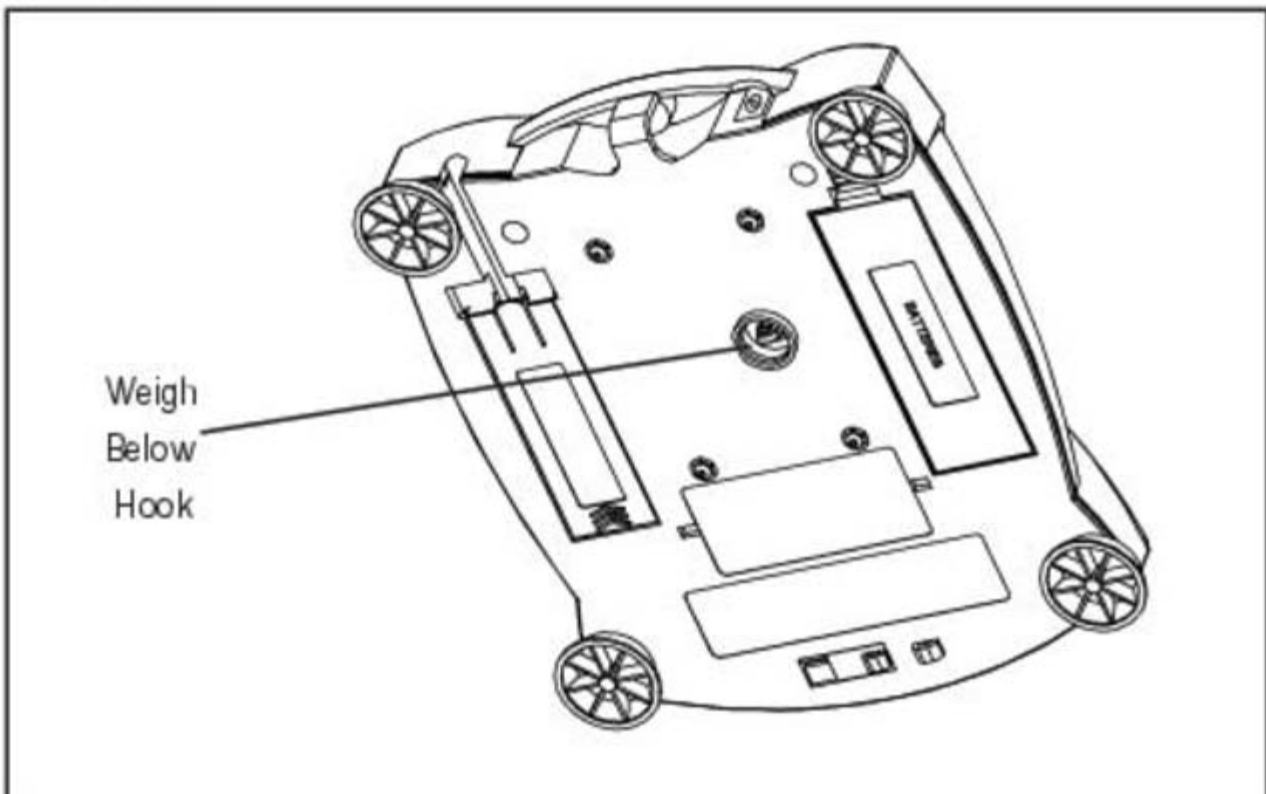

Lock Switch

The Lock Switch is used to lock out the menu mode preventing unauthorized changes. To lock the menus, position the Lock Switch next to the tab on the bottom of the balance as shown.

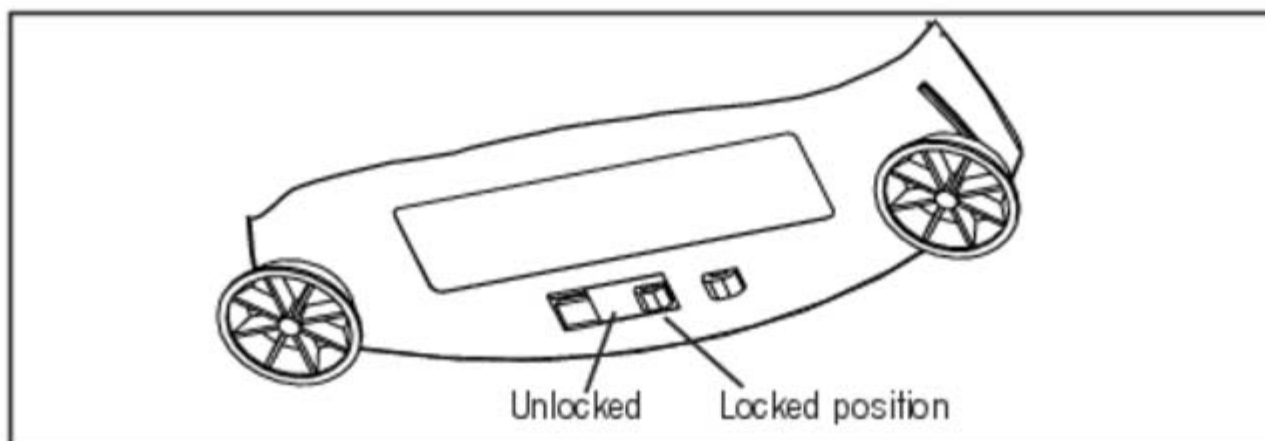

Lock Switch

4. MAINTENANCE

Cleaning

To ensure proper balance operation, keep the housing and platform clean. If necessary, a cloth dampened with a mild detergent may be used. Check under the platform for debris and remove. Keep calibration masses in a safe dry place. Unplug the AC Adapter when not in use. For long term storage, remove the batteries.

Troubleshooting

SYMPTOM	PROBABLE CAUSE	REMEDY
No display.	1. Power Adapter not connected. 2. Batteries are exhausted.	1. Connect AC Adapter. 2. Replace batteries.
Battery Indicator is flashing.	Batteries are weak.	Replace batteries.
Incorrect weight reading.	1. Balance out of calibration. 2. Balance was not rezeroed before weighing.	1. Calibrate the balance. 2. Press the ON/ZERO ON button with no weight on the platform, then weigh item.
Calibration procedures do not work.	Incorrect calibration masses being used.	1. Use correct masses. 2. See error codes note ERR4.
Unable to display weight in a particular weighing unit.	1. Weighing unit not activated in menu. 2. Mode prevents unit change.	1. Use Units menu to set desired units ON. 2. Exit Hold or Totalize mode.
Balance readings unstable.	Balance location may have drafts from air conditioning vents or vibration from other appliances nearby affecting operation.	Either move or shield the balance from external air currents or vibration.
Errorcode is displayed.	Various internal and external problems	Review error code table and take appropriate action.

Error Codes List

When internal and some external problems occur with the balance, the internal software will display messages as error codes. Explanations are given for possible problems. Try remedies in order indicated.

Error Codes

- | | |
|---------------------|---|
| Err 1 chEct | Invalid checksum data
a) Cycle balance ON/OFF,
b) Return balance for servicing. |
| Err 2 LoAd | Overload (>cap+90d) or Underload
a) Remove load,
b) Check shipping lock,
c) Recalibrate. |
| Err 4 WEIght | Incorrect calibration weight
a) Use correct calibration weights,
b) Check environmental conditions. |
| Err 5 999999 | Displayed value >99999
a) Exit application,
b) Rezero balance. |
| Err 6 count | Parts counting error - balance exits parts counting
a) Exit application,
b) Rezero balance. |
| Err 8 FULL | RS232 buffer is full
a) Cycle ON/OFF,
b) Check RS-232 settings in balance and computer. |
| Err 9 dAtA | Internal data error. The next button press or a 5 second time-out causes the balance to turn off.
a) Cycle ON/OFF,
b) Return balance for servicing. |

Accessories

RS232 Interface Kit (includes cable)

USB Interface Kit (includes cable)

Specific Gravity Kit

Security Device

Hard Shell Carrying Case

Impact Printer

Impact Printer Paper 5 pack

9-pin to 25-pin SF42 Adapter

Scoops: Aluminum,

3.62 x 4.50 x 1.0"/9.20 x 11.34 x 2.54 cm

Black anodized, aluminum,

3.62 x 4.50 x 1.0"/9.20 x 11.34 x 2.54 cm

Aluminum,

1.5 x 2.00 x 0.43"/3.81 x 5.08 x 1.11 cm

Gold anodized aluminum,

2.25 x 3.00 x 0.75"/5.71 x 7.62 x 1.90 cm

Calibration Masses:

See specification table for required masses.

50g

100g

200g

300g

500g

1000g

2000g

AC Adapters:

120V/60Hz US

230V/50Hz Europe

230V/60Hz Australia

230V/50Hz UK

100V/50Hz Japan

230V/60 Hz China

5. TECHNICAL DATA

Specifications

Item No.	SPx123	SPx202	SPx402	SPx602	SPx401	SPx601	SPx2001	SPx4001	SPx6001	SPx6000
Capacity (g)	120	200	400	600	400	600	2000	4000	6000	6000
Span Calibration Mass (g)	100	200	200	300	200	300	2000	4000	6000	4000
Linearity Calibration Mass (g)	50	100	200	300	200	300	1000	2000	3000	3000
	100	200	400	600	400	600	2000	4000	6000	6000
Readability (g)	0.001	0.01			0.1					1.0
Repeatability (Std. dev. (g))	0.003	0.01			0.1					1.0
Linearity (g)	±0.003	±0.01		±0.02	±0.1				±0.2	±1.0
Weighing modes	%, Parts Counting - Units, see capacity/readability table									
Tare range	To capacity by subtraction									
Oversrange capacity	Capacity +60d									
Stabilization time	3 seconds									
Operating temp. range	50° - 104°F / 10° - 40°C									
Power requirements	AC Adapter (supplied) or 4 AA batteries (not included)									
Calibration	digital calibration from keypad									
Display (in/mm)	LCD (0.6 / 15 high digits)									
Pan size (in/mm)	4.7 / 120 diam.					6.5 x 5.6 / 165 x 142				
Dimensions WxHxD (in/mm)	7.5 x 2.2 x 8.3 / 192 x 54 x 210									
Net Weight (lb/kg)	2.0 / 0.9		1.5 / 0.7			1.8 / 0.8				

Capacity x Readability

	SPx123	SPx202	SPx402	SPx602	SPx401	SPx601	SPx2001	SPx4001	SPx6001	SPx6000
gram g	120.00 x 0.001	200.00 x 0.01	400.00 x 0.01	600.00 x 0.01	400.0 x 0.1	600.0 x 0.1	2000.0 x 0.1	4000.0 x 0.1	6000.0 x 0.1	6000.0 x 1
ounce oz avoirdupois	4.23290 x 0.00005	7.08550 x 0.00005	14.1096 x 0.00005	21.1645 x 0.00005	14.110 x 0.00005	21.165 x 0.00005	70.550 x 0.00005	141.096 x 0.00005	211.645 x 0.00005	211.65 x 0.00005
pound lb avoirdupois				1.32280 x 0.00005		1.3230 x 0.00005	4.4090 x 0.00005	8.8185 x 0.00005	13.2280 x 0.00005	13.230 x 0.00005
kilogram kg							2.0000 x 0.00001	4.0000 x 0.00001	6.0000 x 0.00001	6.000 x 0.00001
newton N	1.17680 x 0.000001	1.9613 x 0.00001	3.9227 x 0.00001	5.8840 x 0.00001	3.923 x 0.00001	5.884 x 0.00001	19.613 x 0.00001	39.227 x 0.00001	58.884 x 0.00001	58.84 x 0.00001

NOTE: SPGxxxx models only contain SI units.

RS232 Interface

Instruction Manual

INTRODUCTION

This Interface Kit is for use with the following products: Scout Pro, Traveler and Navigator.

INTERFACE INSTALLATION

Install the Interface module on the underside of the balance as shown.

Note: The appearance of your model may be different.

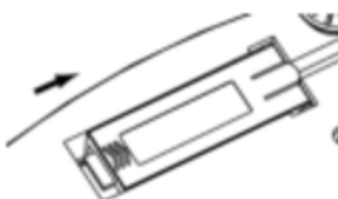

1. Slide Blank Cover to rear.

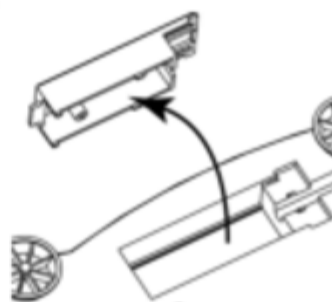

2. Remove the Blank Cover.



3. Install Interface Module.

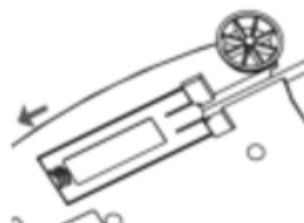

4. Slide Module forward.

SETUP

- A) The interface is preset to communicate using the following settings: 2400 baud, 7 bit, no parity, no handshake. Determine the RS232 parameters required for the printer or computer that is to be connected. See computer or printer documentation if assistance is required. If the parameters do not match, it will be necessary to change either the balance settings, or the computer / printer settings.
- B) Upon installation of the interface, the balance will recognize the RS232 interface and add relevant items to the menu. Configure the balance to the desired RS232 and printing parameters; refer to the balance User Manual for assistance in using the menus.

PRINT

Stable

On, Off

A-Print

Cont, On, Stbl, On Acc*, 5sec, 15sec,
30sec, 60sec, off

End

Yes, No

*Note: Print and RS232 menu selections may vary between the different balance series.

RS232

RS232

On / off

Baud

600, 1200, 2400, 4800, 9600, 19200

Parity

7-even, 7-odd, 7-none, 8-none

Handshake

None, Xon-Xoff, RTS-CTS

END

Yes, No

SETUP DEFINITIONS

PRINT / Stable - On	Balance transmits stable data only.
PRINT / Auto Print – Continuous	Balance repeatedly sends data as fast as possible.
PRINT / Auto Print – On Stable	Balance automatically outputs data upon stability.
PRINT / Auto Print – (xx) sec	Balance sends data every (xx) seconds.
PRINT / Auto Print – Off	Only sends data when PRINT is pressed.
RS232 / RS232 –Off	Turns Interface off, saving battery power.
RS232 / Baud, Parity, Handshake	Set parameters to match printer or computer.

CONNECTION

The RS232 Interface Kit cable terminates with a 9 pin Sub-D female connector.

Active pins: Pin 2 = TXD, Pin 3 = RXD, Pin 5 = Ground, Pins 4 and 6 are connected for hardware handshake, Pin 7 = CTS, Pin 8 = RTS.

The Interface connector will connect directly to a computer, an Ohaus printer and many other printers.

OPERATIONRS232 OUTPUT

With the Adapter installed the balance will operate in one of the following three ways:

- RS232 = on, Auto Print = off, Stable = on or off
Pressing PRINT will send the display data.
If Stable is set to On, the balance will wait for a stable reading before sending data.
- RS232 = on, Auto Print = on, Stable = on or off
The balance will automatically send data based on the settings in the Menu.
If Stable is set to On, only stable values will be sent.
- RS232 = off
The interface is turned off. During battery operation, this saves significant power.

Data sent from the Interface is in standard ASCII format terminated with a [CRLF] (carriage return-line feed). The output format is as follows:

[weight]	10 characters (right justified)	
[space]	1 character	
[unit]	5 characters max (left justified)	
[space]	1 character	
[stability indicator]	1 character	"?" when unstable, blank when stable
[space]	1 character	
[legend]	10 character	TOTAL, hh:mm:ss (time interval), etc.
[CR]	1 character	
[LF]	1 character	

Output examples: (Note: * and _ indicate spaces)

```
*****192.21_g
*****0.01_g_?

*****0.01_g__ 00:00:00
*****176.30_g_?_00:00:15
*****192.08_g__00:00:30

*****192.21_g
*****207.80_g_TOTAL
```

- Manual, Continuous or On-Stable printing
unstable reading

- Interval Printing (example 15sec interval)
unstable reading

- Accumulate Mode (Manual printing only)

RS232 INPUT

The balance will respond to various commands sent via the interface adapter. Terminate the following commands when with a [CR] or [CRLF].

Scout Pro and Traveler Commands

? print current mode
0A turn Auto-print off
SA Auto-print on, prints on stability
CA Continuous Auto-print
(n)A Auto-print on 1 to 3600 second intervals (n = 1 to 3600)
C perform span calibration
L perform linearity calibration
0M gram mode
1M ounce mode
2M troy ounce mode
3M pennyweight mode
4M parts counting mode
5M pound mode
T tare balance, same as pressing **0N-ZERO**
V print software version
(Esc)R reset balance to factory defaults
P same as pressing **PRINT**
LE print last error code, i.e. [Err 0]
0S print unstable data
1S print stable data only

Navigator Commands

P same as pressing **Print**
SP print stable weight only
IP immediate print of displayed weight (stable or unstable)
CP Continuous print of weights
SLP Auto-print stable non-zero weight only
SLZP Auto-print stable non-zero weight and zero reading
xP Auto-print on 1 to 3600 second intervals (x = 1 to 3600)
0P turns auto-print off
PM print current mode

M	advance to the next enabled mode
PU	print current unit
U	advance to the next enabled unit
T	same as pressing Tare
Z	same as pressing Zero
PV	print software version

AUTO-PRINT OPERATION

Once Auto-Print is activated in the menu, the balance will send data as required. To temporarily stop Auto-Printing, press the PRINT key. If there is data in the print buffer the printer will finish printing this data. A second press will resume Auto-Printing.

COMPLIANCE

This accessory has been tested and complies with the approvals listed in the applicable Instruction Manual.

Disposal



In conformance with the European Directive 2002/96 EC on Waste Electrical and Electronic Equipment (WEEE) this device may not be disposed of in domestic waste. This also applies to countries outside the EU, per their specific requirements.

Please dispose of this product in accordance with local regulations at the collecting point specified for electrical and electronic equipment. If you have any questions, please contact the responsible authority or the distributor from which you purchased this device.

Should this device be passed on to other parties (for private or professional use), the content of this regulation must also be related.

Thank you for your contribution to environmental protection.