

DUNE SERIES

(P.N. 9384, Revision A1, August 2008)

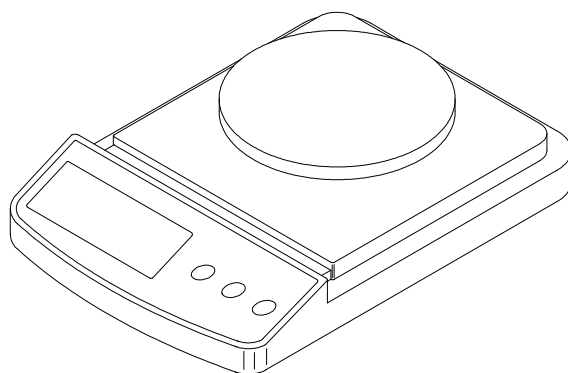

Easy Reference:

| | |
|--|--|
| Model name of the scale: | |
| Serial number of the unit: | |
| Software revision number (Displayed when power is first turned on): | |
| Date of Purchase: | |
| Name of the supplier and place: | |

1.0 CONTENTS

| | | |
|-----|---|----|
| 1.0 | CONTENTS..... | 3 |
| 2.0 | INTRODUCTION..... | 3 |
| 3.0 | SET UP..... | 4 |
| 3.1 | UNPACKING AND SETTING UP YOUR SCALE | 4 |
| 3.2 | LOCATING AND PROTECTING YOUR SCALE | 5 |
| 4.0 | BASIC OPERATION | 6 |
| 4.1 | TURING ON THE SCALE..... | 6 |
| 4.2 | ZEROING / TARE..... | 6 |
| 4.4 | WEIGHING | 6 |
| 5.0 | FUNCTIONS | 7 |
| 5.1 | AUTO POWER OFF | 7 |
| 6.0 | CALIBRATION | 7 |
| 7.0 | TROUBLE SHOOTING..... | 8 |
| 7.1 | ERROR MESSAGES..... | 8 |
| 7.2 | REPLACEMENT PARTS AND ACCESSORIES..... | 8 |
| 8.0 | SPECIFICATIONS..... | 9 |
| 9.0 | WARRANTY STATEMENT..... | 10 |

2.0 INTRODUCTION

Thank you for purchasing the **Dune™** compact scales, Every **Dune** is equipped with the features you really need: AC adapter, auto-calibration through the keypad, low-battery indicator, and overload indicator. With its alternate battery operation, splash-proof key pad, and sturdy plastic construction throughout, the Dune will deliver accurate readings both indoors and out.

3.0 SET UP

3.1 UNPACKING AND SETTING UP YOUR SCALE

- 1) Remove the top pan and card board packaging between top pan and machine.
- 2) Connect the power adapter to the socket on the back of the machine.

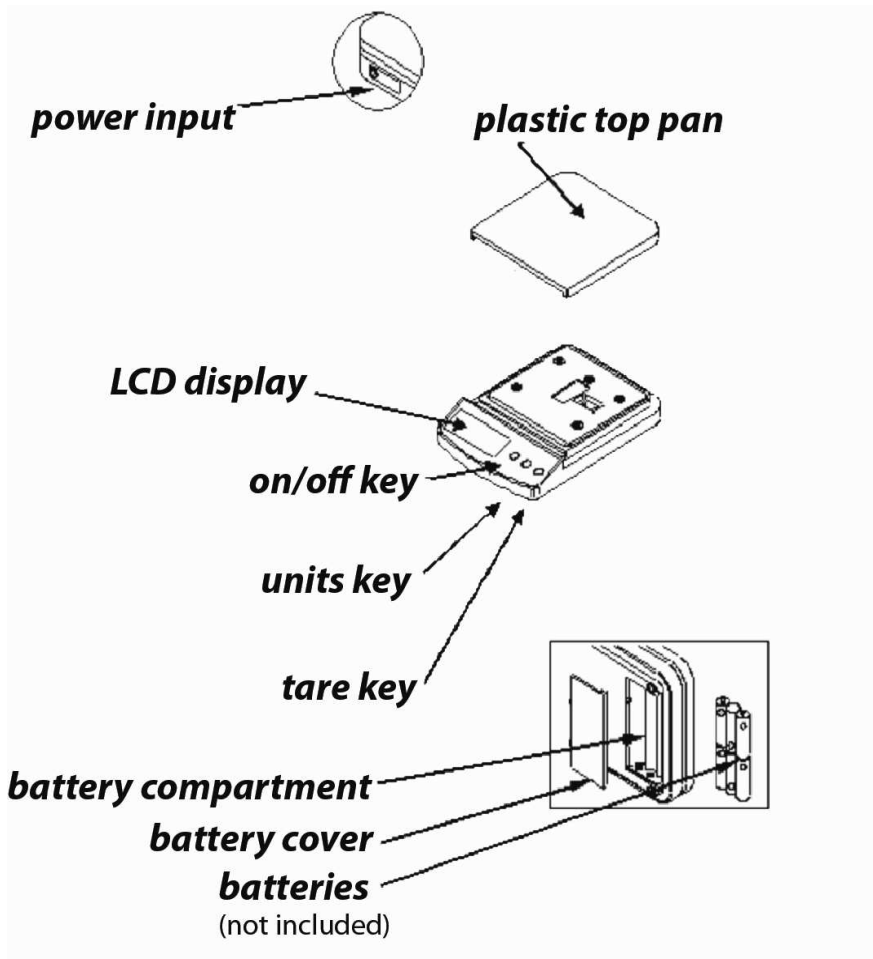

Installing Batteries:

Remove the battery compartment cover and insert six batteries (R6P/LR6 /AA size) into the battery compartment taking extreme care that the polarities plus and minus are observed.

3.2 LOCATING AND PROTECTING YOUR SCALE

In order to keep you scale functioning at its best we suggest that you do the following:



Avoid extremes of temperature. Do not place in direct sunlight or near air conditioning vents.



Make sure the scale is located on a strong table and free from vibration.

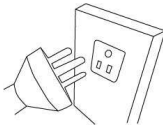

Avoid unstable power sources. Do not use near large users of electricity such as welding equipment or large motors. Do not mix batteries and use only the factory approved power adapter supplied with the machine. Do not use batteries and the AC adapter at the same time.

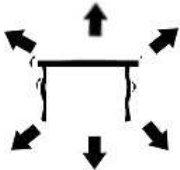

Keep free from vibration. Do not place near heavy or vibrating machinery.



Avoid high humidity that might cause condensation. Keep away from direct contact with water. Do not spray or immerse the scales in water.

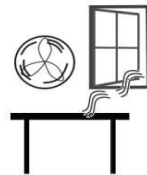

Do not place near open windows, air-conditioning vents or fans that may cause a draft and unstable readings.

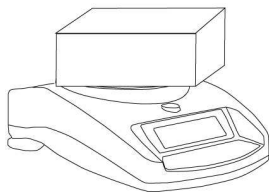

Keep the scales clean. Do not stack material on the scale / balance when it is not in use.

4.0 BASIC OPERATION

4.1 TURING ON THE SCALE

Plug in the unit using the AC adapter or use batteries. Do not use battery power and the AC adapter at the same time.

- 1) To turn on press the **[on/off]** key once and release. All of the segments on the display will light up, then the display shows zero **>0<**
- 2) The scale is ready to be use.
- 3) To turn the scale off after use press the **[on/off]** key again. There is an auto power-off function that will automatically turn the unit off after 4 min of inactivity or no change in the weight reading.

4.2 ZEROING / TARE

You can press the **[Tare]** key to set a new zero point and show the zero reading if the weight reading is less than 4% of the total of the maximum capacity of the scale. This may be necessary if the weight is not reading zero with nothing on the platform. The zero indicators will light up: **>0<**.

If you are using a container to weigh then you can place this on the platform and press the **[Tare]** key, providing the container weight is more than 4% of the maximum capacity of the scale, the display will show zero and tare indicator will light up. You can then weigh your object in the container. Taring weight subtracts from the total scale capacity.

Note: When the container is removed a negative value will be shown. If the scale was tared just before removing the container, this value is the gross weight of the container plus all products which were removed.

4.4 WEIGHING

To determine the weight of a sample, first tare an empty container (if used), then place the sample in the container. The display will show the weight and the unit of weight currently in use.

5.0 FUNCTIONS

5.1 AUTO POWER OFF

The auto power off helps conserve power when using on battery or the AC adapter, the machine will automatically turn off after 4 min of inactive use or no change in the displayed weight.

6.0 CALIBRATION

Before calibrating the Dune series it is best to turn on the unit for about 1 min to let the components warm up.

- 1) Press **[on/off]** key to turn the power on, if it is not already.
- 2) Press and hold the **[Unit]** key, until **"CAL"** is displayed
- 3) Remove any weight from the pan.
- 4) Press the **[Unit]** key, the display will flash **"CAL"** then will show the cal mass required. If the cal mass is not displayed then the machine is not stable or is not within a zero range. Turn off the unit and try zeroing the display before trying another calibration.
- 5) Place the appropriate calibration mass on the scale:

| Model | Calibration Mass |
|----------|------------------|
| DCT 201 | 200g |
| DCT 2000 | 2000g |
| DCT 5000 | 5000g |

- 6) After the stable reading the display will show **"PASS"** then revert to the weighing mode. If the calibration does not pass the display will show **"FAIL"** and shut off.
- 7) The calibration is now finished. If the calibration is correct, the display will show the weight value.

NOTE: If the calibration fails retry, if it still fails then there may be damage to the mechanics or an issue with the power. If you do not follow the procedures in a timely manner the machine will automatically switch off and the calibration will not be accepted.

7.0 TROUBLE SHOOTING

7.1 ERROR MESSAGES

If an error message is shown, repeat the step that caused the message. If the error message is still shown then contact your dealer for support.

| ERROR CODE | DESCRIPTION | POSSIBLE CAUSES |
|--|--------------------------|---|
| 0-Ld | Overload | Remove weight from the pan. Make sure the machine is reading zero before weighing. Do not over load the pan. If the problem recurs calibrate. Possible damage to the mechanics. |
| Out2 | Out of Zero reading | Make sure the pan is fitted correctly. Make sure nothing is touching the pan when turning on the unit. Calibrate the machine. Possible damage to the mechanics. |
| UnSt | Unstable | Make sure the balance is on a flat surface and away from vibration. Possible damage to the mechanics. |
| LO or  | Low Battery indicator | Change the batteries or use on the power adapter. |
| ErrE | E-Prom error | Software error turn off and restart. Contact Adam Equipment or your dealer for further assistance. |
| | No Power when turning on | Change the batteries or use on the power adapter. |

7.2 REPLACEMENT PARTS AND ACCESSORIES

If you need to order any spare parts and accessories, contact your supplier or Adam Equipment. A partial list of the more common items follows:

| Part Number | Description |
|-------------|-----------------------------------|
| 9402 | AC adapter (Country Dependent) |
| 9401 | Plastic pan |

8.0 SPECIFICATIONS

| Model # | DCT-201 | DCT-2000 | DCT-5000 |
|--------------------------------|---|-------------|----------|
| Maximum Capacity | 200g | 2000g | 5000g |
| Readability | 0.1g | 1g | 2g |
| Repeatability (Std Dev) | 0.1g | 1g | 2g |
| Linearity ± | 0.2g | 2g | 4g |
| Units of Measure | g / oz | g / lb / oz | |
| Stabilisation Time | 2 seconds | | |
| Operating Temperature | 0°C to 40°C 32°F to 104°F | | |
| Power Supply | 12VAC @ 150mA adapter or 6x AA batteries | | |
| Calibration | Push button calibration using external mass | | |
| Calibration Mass | 200g | 2000g | 5000g |
| Display | 5 digit LCD display 15mm high | | |
| Balance Housing | ABS Plastic | | |
| Pan Size | 145 x 145mm 5.8" x 5.8" | | |
| Overall Dimensions (w x d x h) | 145 x 210 x 40mm 5.8" x 8.3" x 1.6" | | |
| Gross Weight | 1kg, 2.2lb | | |
| Features | Low battery, Stable and Zero indications | | |

9.0 WARRANTY STATEMENT

Adam Equipment offers Limited Warranty (Parts and Labour) for the components failed due to defects in materials or workmanship. Warranty starts from the date of delivery.

During the warranty period, should any repairs be necessary, the customer must inform the supplier or Adam Equipment. The company or its authorised Technician reserves the right to repair or replace any components at its own discretion. Any shipping costs involved in sending the faulty units to a service centre is the customers responsibility.

The warranty will cease to operate if the equipment is not returned in the original packaging and with correct documentation for a claim to be processed. All claims are at the sole discretion of Adam Equipment.

This warranty does not cover equipment where defects or poor performance is due to misuse, accidental damage, exposure to radioactive or corrosive materials, negligence, faulty installation, unauthorised modifications or attempted repair or failure to observe the requirements and recommendations as given in this User Manual.

Repairs carried out under the warranty does not extend the warranty period. Components removed during the warranty repairs become the company property.

The statutory right of the purchaser is not affected by this warranty. The terms of this warranty is governed by the English Law. For complete details on Warranty Information, see the terms and conditions of sale available on our web-site.

Manufacturer's Declaration of Conformity

This product has been manufactured in accordance with the harmonised European standards, following the provisions of the below stated directives:

Electro Magnetic Compatibility Directive 2004/108/EC

Low Voltage Directive 2006/95/EC

Adam Equipment Co. Ltd.
Bond Avenue, Denbigh East
Milton Keynes, MK1 1SW
United Kingdom



FCC COMPLIANCE

This equipment has been tested and found to comply with the limits for a Class A digital device, pursuant to Part 15 of the FCC Rules. These limits are designed to provide reasonable protection against harmful interference when the equipment is operated in a commercial environment. The equipment generates, uses, and can radiate radio frequency energy and, if not installed and used in accordance with the instruction manual, may cause harmful interference to radio communications. Operation of this equipment in a residential area is likely to cause harmful interference in which case the user will be required to correct the interference at his own expense.

Shielded interconnect cables must be employed with this equipment to insure compliance with the pertinent RF emission limits governing this device.

Changes or modifications not expressly approved by Adam Equipment could void the user's authority to operate the equipment.

WEEE COMPLIANCE

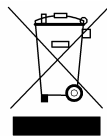

Sealed Lead Acid
Battery
Must be recycled
Properly

Any Electrical or Electronic Equipment (EEE) component or assembly of parts intended to be incorporated into EEE devices as defined by European Directive 2002/95/EEC must be recycled or disposed using techniques that do not introduce hazardous substances harmful to our health or the environment as listed in Directive 2002/95/EC or amending legislation. Battery disposal in Landfill Sites is more regulated since July 2002 by regulation 9 of the Landfill (England and Wales) Regulations 2002 and Hazardous Waste Regulations 2005.

ADAM EQUIPMENT is an ISO 9001:2000 certified global company with more than 35 years experience in the production and sale of electronic weighing equipment.

For a complete listing of all Adam scales and balances visit our website at:

www.adamequipment.com

© Copyright by Adam Equipment Co. Ltd. All rights reserved. No part of this publication may be reprinted or translated in any form or by any means without the prior permission of Adam Equipment.

Adam Equipment reserves the right to make changes to the technology, features, specifications and design of the equipment without notice.

All information contained within this publication is to the best of our knowledge timely, complete and accurate when issued. However, we are not responsible for misinterpretations which may result from the reading of this material.

The latest version of this publication can be found on our Website.

Head Office:

Adam Equipment Co. Ltd.

Bond Avenue,

Milton Keynes,

MK1 1 SW

Tel: +44 (0)1908 274545

FaX: +44 (0)1908 641339

sales@adamequipment.co.uk

For regional office worldwide visit www.adamequipment.com