

Instructions

Index

1. Introduction
- 1.1 Features
2. Inventory of contents
- 2.1 Feature of the base station
- 2.2 Feature of the thermo-hygro sensor
- 2.3 Feature of wind sensor
- 2.4 Feature of rain sensor
3. Set up guide
- 3.1 Battery installation
- 3.2 Mounting
4. LCD display
- 4.1 LCD overview
- 4.2 Weather forecast
- 4.3 Weather forecast tendency indicator
- 4.4 Storm warning indicator
5. Program modes
- 5.1 Quick display mode
- 5.2 Setting mode
- 5.3 History mode
- 5.4 Alarm mode
- 5.5 Min/Max mode
6. Specification
7. Battery replacement, Maintenance, Liability disclaimer

1. Introduction

This new wireless weather station consists on a base station with indoor sensors for room temperature, humidity and atmospheric pressure and several outdoor sensors for measuring outdoor temperature, humidity, wind velocity and quantity of rainfall.

So you get useful information about climate and weather in and around your house. This is fun and makes you curious to know more.

Please read this instruction manual thoroughly to fully understand the correct operation of your weather station and benefit from its unique features.

1.1 Features

- Wireless transmission of outdoor temperature, humidity, quantity of rainfall and wind velocity from the exterior sensors to the display station (868 MHz)
- Particularly secure data transmission by connecting each transmitter with cable, long-distance range up to 100 m (free field)
- Indoor temperature and humidity
- Weather forecast with symbols and tendency of atmospheric pressure
- Absolute and relative atmospheric pressure
- Bar graph indication of atmospheric pressure for the last 24 hours
- 24 hours history
- Windchill factor and dewpoint
- Programmable alarm functions for certain weather conditions, like temperature alarm, storm warning
- Maximum and minimum values with time and date of recording
- Radio controlled clock with alarm and date
- Time zone ± 12 hours, manual time setting possible
- Backlight (when using buttons)
- For wall mounting or table standing

2. Inventory of contents

Content

Display Station:

- Batteries 3 x 1,5 V AA

Sensor:

- Thermo-Hygro-Sensor
- Batteries 2 x 1,5 V AA
- Rain protection cover
- Wind sensor
- Rain sensor
- 2 connecting cables to Thermo-Hygro-Sensor
- Mast
- Mounting material

Manual

2.1 Base station

Front view



Back view

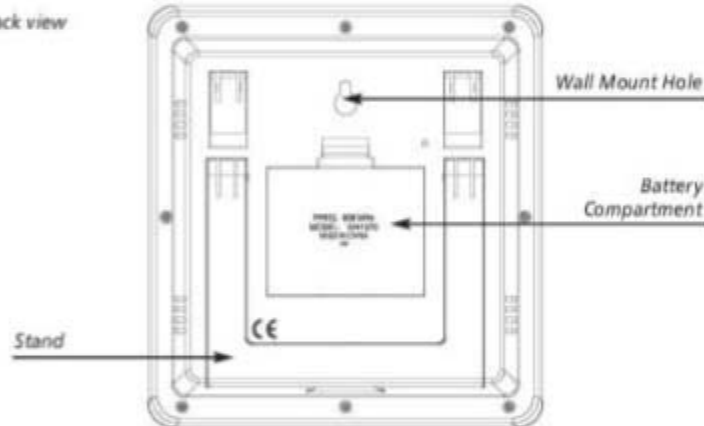

2.2 Thermo-hygro sensor

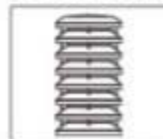

The thermo-hygro sensor measures the outdoor temperature and humidity. In addition it is the main data communication unit: The wind and rain sensors are connected to the thermo-hygro sensor for operating power and to communicate to the base station. Weather data sent from the thermo-hygro sensor is transmitted through wireless link. The radio controlled time receiver is built inside the sensor.

2.3 Wind sensor

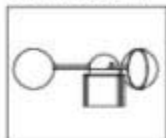

The wind sensor measures wind speed and sends the data to the thermo-hygro sensor, which in turn transmits the data to the base station. Operating power is taken from the thermo-hygro sensor by a cable connection.

2.4 Rain sensor

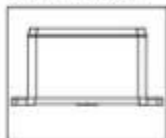

The rain sensor measures the rainfall and sends the data to the thermo-hygro sensor, which in turn transmits the data to the base station. Operating power is taken from the thermo-hygro sensor by a cable connection.

3. Set up Guide

- Before placing and installing all components of the weather station at their final destination, please set up the weather station with all parts being nearby for testing the correct function.

3.1 Battery installation

Thermo-hygro sensor

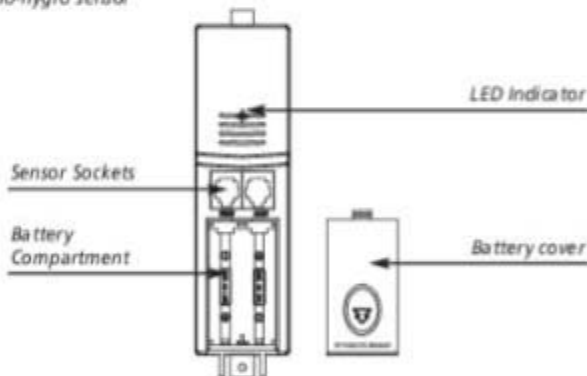

- Pull away the shower proof casing of the thermo-hygro sensor to reveal the two sockets (for the wind sensor and rain sensor)
- Connect the attached cables of wind and rain sensors to the corresponding sockets of the thermo-hygro sensor by clicking them into place. Make sure not to swap the sockets.
- Open the base station's battery cover located at the back of the unit and insert 3 x AA, 1.5V Alkaline batteries into the battery compartment and close the battery cover
- Open the battery cover of the thermo-hygro sensor located below the two sockets and insert 2 x AA, 1.5V Alkaline batteries and close the cover.

Transmission of outdoor values and DCF time

- When the base station is powered up, a short beep will sound and all LCD segments will light up for about 3 seconds before it enters into learning mode to learn the sensors security code.
- When the thermo-hygro sensor is powered up (also after a change of batteries), the LED indicator will light up for 4 seconds. If the LED doesn't light up, make sure the battery is inserted the correct way.
- After the thermo-hygro sensor is powered up, the sensor will transmit weather data for 24s, and then the sensor will start radio controlled time reception. During the DCF time reception period (maximum 5 minutes), no weather data will be transmitted. The LED indicator will be blinking 5 times once DCF signal was synchronized.
Note: DO NOT PRESS ANY KEY during the first 10 minutes learning period or before radio controlled time is displayed on the receiver. After both outdoor weather data and radio controlled time are displayed you can place your remote sensor outdoors at the final destination. In case the clock cannot detect the DCF-signal (for example due to disturbances, transmitting distance, etc.), the time can be set manually. If the outdoor weather data is not displayed or if any key is pressed before the weather station receives the signal, you will need to follow the battery installation procedure again. **Please wait minimum 10 seconds before re-inserting the battery to make a proper reset for both transmitter and receiver.**

Note for Radio Controlled Time DCF

- The time base for the radio controlled time is a Caesium Atomic Clock operated by the Physikalisch Technische Bundesanstalt Braunschweig which has a time deviation of less than one second in one million years. The time is coded and transmitted from Mainflingen near Frankfurt via frequency signal DCF-77 (77.5 kHz) and has a transmitting range of approximately 1,500 km. Your radio-controlled clock receives this signal and converts it to show the precise time in summer or wintertime. The quality of the reception depends greatly on the geographic location. In normal cases, there should be no reception problems within a 1,500 km radius around Frankfurt.

Please take note of the following:

- The radio controlled time receiver is built inside the thermo-hygro-sensor. It is recommended to keep distance to any interfering sources and ferro-concrete buildings.
- During night-time, the atmospheric disturbances are usually less severe and reception is possible in most cases. A single daily reception is adequate to keep the accuracy deviation below 1 second.
- If the reception is not successful, the DCF reception symbol disappears, but the DCF time reception will be repeated again. The manually set time will be overwritten by the DCF time when the signal is received successfully.

3.2 Mounting

- Before installing the sensors and the base station at their final destination please check if the data transmission is continuously possible (transmission range max. 100 m free field, within ferro-concrete rooms the received signal is naturally weakened). If necessary chose another position for transmitter and / or display unit.

1) Base station

With the foldable leg at the back of the unit, the base station can be placed onto any flat surface or wall mounted at the desired location by the hanging hole at the back of the unit.

2) Remote sensor

For accurate results, the remote sensor mast should be securely mounted onto a horizontal surface and in an open area away from trees or other coverings where rainfall or wind speed may be reduced causing inaccurate reading.

a.) Mounting the wind sensor

Assemble the mast. Firstly, check that the wind-fan can rotate freely before fixing the unit. The wind sensor should now be mounted using the screw onto a mast provided to allow the wind to travel around the sensor unhindered from all directions.

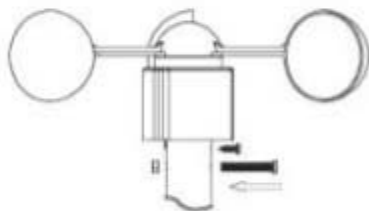
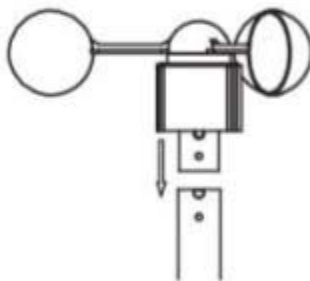
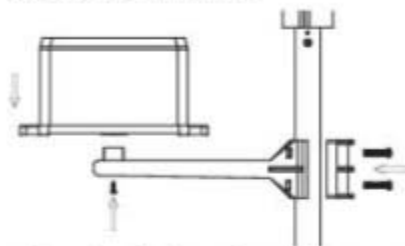
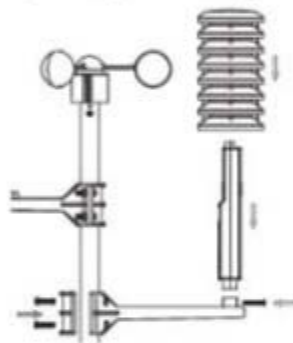
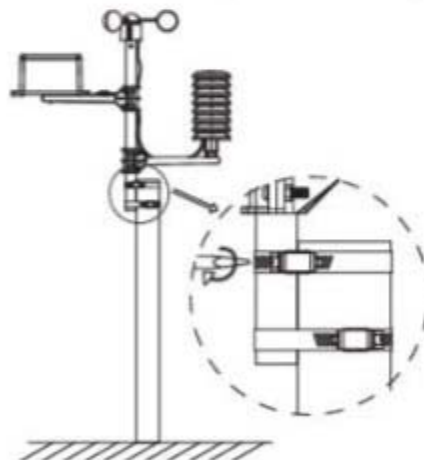
**b.) Mounting the rain sensor****c.) Mounting the thermo-hygro sensor same as rain sensor****d.) Fix the whole set to a pole with the two adjustable hoops.**

Once the wind sensor and rain sensor are fixed onto the mast, connect the cable to the corresponding thermo-hygro sensor socket.

4. LCD display

4.1 LCD overview

The following illustration shows the full segments of the LCD for description purposes only and will not appear like this during normal operation and use.

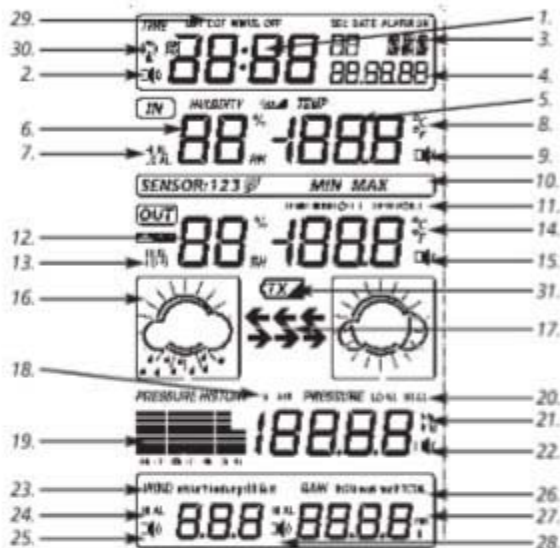

- | | |
|---|--|
| 1. Time | 16. Weather forecast icon |
| 2. Alarm on indicator | 17. Weather tendency indicator |
| 3. Day of week / time zone / history | 18. Pressure unit (relative or absolute) |
| 4. Date | 19. Pressure with 24 hour history graph |
| 5. Indoor temperature display | 20. Pressure low alarm and high alarm |
| 6. Indoor humidity display | 21. Pressure display unit (inHg or hPa) |
| 7. Indoor temperature and humidity low alarm and high alarm | 22. Pressure alarm on indicator |
| 8. Temperature display unit | 23. Wind speed display unit (m/s, km/h, knots, chill mph, bft) |
| 9. General indoor alarm icon | 24. Wind speed high alarm |
| 10. MIN/MAX information | 25. Wind alarm on indicator |
| 11. Wind chill and dew point temperature display | 26. Rainfall 1h, 24h, week, month or total hour display |
| 12. Outdoor temperature and humidity display | 27. Rainfall display unit (mm/in) |
| 13. Outdoor temperature and humidity low alarm and high alarm | 28. Rainfall alarm on indicator |
| 14. Temperature display unit | 29. Radio controlled time version DCF |
| 15. General outdoor alarm icon | 30. Radio controlled time icon |
| | 31. Lower battery indicator (transmitter) |

4.2 Weather forecast

The four weather icons Sunny, Partly Cloudy, Cloudy and Rainy represent the weather forecast.

The weather forecast symbols indicate an improvement or worsening of the future weather conditions based on the current weather, which doesn't have to correspond exactly with the weather indicated on the symbol.

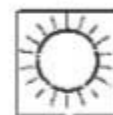

Sunny



Partly cloudy



Cloudy



Rainy

4.3 Weather forecast tendency indicator

The weather tendency indicators arrow is located between the weather icons to show the air pressure tendency and provide a forecast of the weather to be expected by the decreasing or increasing air pressure. The rightward arrow means that the air pressure is increasing and the weather is expected to become better. The leftward arrow means that the air pressure is decreasing and the weather is expected to become worse.

The change of weather forecast icon is in accord to the relationship between current relative pressure and the pressure change since last twelve hours. If the weather is changing, weather tendency indicator (animated arrows) will be flashing. And after the next three hours if weather conditions have become stable, the arrows will fix indicating a stable condition happened.

Examples of changing weather icons:

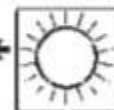

Notes to pressure sensitivity setting for weather forecasting:

The pressure threshold can be set to suit the user's requirement for weather forecasting from 2-4hPa (default 2hPa). For areas that experience frequent changes in air pressure requires a higher setting compared to an area where the air pressure is stagnant. For example if 4hPa is selected, then there must be a fall or rise in air pressure of at least 4hPa before the weather station will register this as a change in weather.

4.4 Storm warning indicator



The storm threshold can be set to suit the user's requirement for storm forecasting from 4-9hPa (default 4hPa). When there is a fall over pressure threshold within 3 hours, the storm forecasting will be activated, the clouds with rain icon and tendency arrows will flash for 3 hours indicating the storm warning feature has been activated.

5. Program Modes

The base station has five keys for easy operation: **SET** key, **+** key, **ALARM** key, **HISTORY** key and **MIN/MAX** key. And there are five program modes available: Quick Display Mode, Setting Mode, Alarm Mode, History Mode and Min/Max Mode.

The program mode can be exited at any time by either pressing the **HISTORY** key, or waiting for the 10-second time-out to take effect.

5.1 Quick Display Mode

In Quick Display Mode you get a quick information about several weather data. While in Normal Mode, press the **SET** key to enter the Quick Display Mode and to toggle through the display mode. Press **+** key or **MIN/MAX** key to select the desired information:

1. Outdoor Temperature / Wind chill / Dew point
2. Absolute pressure / Relative pressure
3. Wind speed / Gust speed
4. 1 hour / 24 hour / week / month / total rainfall quantity

Press the **SET** key for two seconds while the rainfall total quantity is displayed to reset the rainfall total value to zero and to cumulate the rainfall quantities until the next reset.

5.2 Setting Mode

- Press the **SET** key for 3 second while in normal mode to enter the normal Setting mode.
- In the setting modes, press **+** key or **MIN/MAX** key to select the units or scrolls the value. Holding the **+** key or **MIN/MAX** key for 3 second will increase/decrease digits in great steps.
- Press the **SET** key to select the following setting in sequence:
 1. Time Zone Setting ± 12 hrs.: The time zone is used for countries where the DCF signal can be received but the time zone is different from the German time (e.g. +1=one hour later).
 2. 12/24 hour format
 3. Manual time setting (hours/minutes)
 4. Calendar setting (year/month/date, weekday will be calculated thus no need to set weekday)
 5. Temperature display unit degree Celsius or Fahrenheit
 6. Air pressure display units in hPa or inHg
 7. Relative pressure setting from 300hPa – 1100hPa (default 1013.2hPa). Relative pressure is referred to sea level's pressure and has to be adjusted first to your local altitude. Ask for the present atmospheric pressure of your home area (Local weather service, www, optician, calibrated instruments in public buildings, airport).
 8. Pressure threshold setting (default 2hPa, see 4.3)
 9. Storm threshold setting (default 4hPa, see 4.4)
 10. Wind speed and gust display units in km/h, mph, m/s, knots, bft
 11. Rainfall display units in mm or inch

Note: Please set the units firstly before change units' value. During change of units setting, the previous set value will be changed according to the new units. However it might cause resolution loss due to its internal calculation algorithm.

5.3 History Mode

- While in Normal Mode, press the **HISTORY** key to enter the History Mode.
- In the History Mode, press the **+** key to select the record over the past 24hours at increments of -3 hours, -6 hours, -9 hours, -12 hours, -15 hours, -18 hours, -21 hours, -24 hours

5.4 Alarm Mode

- The weather station can be programmed in that way that in certain weather conditions an alarm is activated. For this purpose an upper (High Alarm) and lower limit (Low Alarm) can be set for many parameters.
- While in Normal Mode press the **ALARM** key to enter the High Alarm Mode.
- Press the **SET** key to select the following alarm modes. Press **+** key or **MIN/MAX** key to set the high alarm value. Press and hold the keys to change the number in great step.
 - Press the **ALARM** key to choose the alarm on or off. "HI AL" and an alarm symbol appears or disappears next to the corresponding parameter in the display.
 1. Time alarm (hours/minutes, at low alarm setting mode, the same time alarm setting sequence will repeat)
 2. Indoor humidity high alarm
 3. Indoor temperature high alarm
 4. Outdoor humidity high alarm
 5. Outdoor temperature high alarm
 6. Wind chill high alarm
 7. Dew point high alarm
 8. Pressure high alarm
 9. Wind speed high alarm
 10. Gust speed high alarm
 11. 1Hour rain high alarm
 12. 24 hour rain high alarm
- While in Normal Mode press twice the **ALARM** key to enter the Low Alarm Mode.
 - Press the **SET** key to select the following alarm modes. Press **+** key or **MIN/MAX** key to set the low alarm value. Press and hold the keys to change the number in great step.
 - Press the **ALARM** key to choose the alarm on or off. "LO AL" and an alarm symbol appears or disappears next to the corresponding parameter in the display.
 1. Time alarm (hours/minutes, at high alarm setting mode, the same time alarm setting sequence will repeat)
 2. Indoor humidity low alarm
 3. Indoor temperature low alarm
 4. Outdoor humidity low alarm
 5. Outdoor temperature low alarm
 6. Wind chill low alarm
 7. Dew point low alarm
 8. Pressure low alarm

Remark: after the initial pressing of **ALARM** key, "- - -" will be displayed for all segments. Later the high and low alarm values appear if they are activated.

Alarm signal

When a set weather alarm condition has been triggered, that particular alarm will sound for 120 seconds. The corresponding value, "HI AL" or "LO AL" and the alarm symbol are flashing until the weather condition doesn't meet the user set level. Press any key to mute the alarm.

Example

Dew point high alarm was triggered:



5.5 Min/Max Mode

- While in Normal Mode, press the **MIN/MAX** key to enter the maximum mode.
- In the maximum reading Mode, press the + key to display the following maximum values together with the time and date stamp when these values were recorded. Press **SET** key while the corresponding maximum value is displayed to reset to the current reading together with the current time and date.

- Indoor humidity maximum
- Indoor temperature maximum
- Outdoor humidity maximum
- Outdoor temperature maximum
- Wind chill temperature maximum
- Dew point temperature maximum
- Pressure maximum
- Wind speed maximum
- Gust speed maximum
- 1Hour rain maximum
- 24 hour rain maximum
- Week rainfall maximum
- Month rainfall maximum

- While in Normal Mode, press twice the **MIN/MAX** key to enter the minimum mode.
- In the minimum reading Mode, press the + key to display the following maximum values together with the time and date stamp when these values were recorded. Press **SET** key while the corresponding minimum value is displayed to reset to the current reading together with the current time and date.

- Indoor humidity minimum
- Indoor temperature minimum
- Outdoor humidity minimum
- Outdoor temperature minimum
- Wind chill temperature minimum
- Dew point temperature minimum
- Pressure minimum

6. Specifications

Transmission distance in open field: 100 meter max.

Frequency: 868MHz

Measuring interval thermo-hygro sensor: 48 sec

Alarm duration: 120 sec

Temperature:

Measuring unit: °C/°F

Measuring range:

outdoor: -40°...+65°C

-40°...+149°F

indoor: 0°...+60°C

32°...+140°F

(show OFL if outside range)

Resolution:

0.1°C

Accuracy:

±1°C

Humidity

Measuring unit: %RH

Measuring range:

10%...99% RH

Resolution:

1%

Accuracy: ±3% for 20...80% RH, otherwise ±5%

Rain volume

Measuring unit:

mm/inch

0 - 9999mm

0-393.6 inch

(show OFL if outside range)

Resolution:

0.3mm (if rain volume < 1000mm)

1mm (if rain volume > 1000mm)

Wind speed

Measuring unit:

Wind speed :

km/h, m/s, mph, knots, Beaufort

0-180km/h / 0-50 m/s, 0-111.8 mph

(show OFL if outside range)

Atmospheric pressure

Measuring unit:

Measuring range:

hPa / inHg

300hPa – 1100hPa

8.85 – 32.5inHg

Resolution:

0.1hPa

Accuracy:

±3hPa

Power consumption

Base station:

Remote sensor:

Battery life:

3 x AA 1.5V LR6 Alkaline batteries

2 x AA 1.5V LR6 Alkaline batteries

About 12 months for base station

About 24 months for thermo-hygro sensor

7. Battery replacement

- Replace the batteries of the base station when the display becomes weak.
- When batteries require replacement for the transmitter, the low battery indicator (TX) will light up on the LCD.

Note: If a battery change for the transmitter happened, the base station will be resynchronized to the transmitter again within the next 3 hours. If you want to shorten the receiving data time, you have to re-install the batteries of the base station as well. But in this case the previous weather data and alarm value settings of the base station will be lost.

- Use alkaline batteries only. Observe correct polarity. Low batteries should be changed soon to avoid the damage resulting from a leaking battery. Batteries contain harmful acids. Wear protective glasses and gloves when handling with leaked batteries.

Attention:

Please do not dispose of old electronic devices and used batteries in household waste. To protect the environment, take them to your retail store or to appropriate collection sites according to national or local regulations.

8. Maintenance

- Keep your weather station in a dry place.
- Do not expose the instrument to extreme temperatures, vibration or shock.
- Clean it with a soft, damp cloth. Do not use solvents or scouring agents.
- Avoid placing the clock near interference sources/metal frames such as computer or TV sets.
- Please reset the unit and follow the battery installation procedure if the unit does not work properly. Change the batteries.

9. Liability disclaimer

- The product is not a toy. Keep it out of reach of children.
- The product is not to be used for medical purpose or for public information, but is determined for home use only.
- The specifications of this product may change without prior notice.
- No part of this manual may be reproduced without written consent of TFA Dostmann.
- Improper use or unauthorized opening of housing will mean the loss of warranty.