

Ray Optics Demonstration Set (RODS)

and

Ray Optics Demonstration Set Plus (RODS+)

USER'S GUIDE

zu beziehen bei

sold by

www.conatex.com



Table of contents

PGS	NO. OF EXP.	TITLE OF EXPERIMENT	SET TO USE
1		<i>Introduction</i>	
2		<i>Tables of the set elements</i>	
3	E1	<i>Reflection on plane mirror</i>	RODS/RODS+
3	E2	<i>Reflection on two plane mirrors</i>	RODS+
3	E3a	<i>Reflection of light rays on concave mirror – rays are parallel to optical axis</i>	RODS
4	E3b	<i>Reflection of light rays on concave mirror – rays are non-parallel to optical axis</i>	RODS
4	E4a	<i>Reflection of light rays on convex mirror – rays are parallel to optical axis</i>	RODS
4	E4b	<i>Reflection of light rays on convex mirror – rays are non-parallel to optical axis</i>	RODS
5	E5a	<i>Refraction of light passing air-glass boundary</i>	RODS
5	E5b	<i>Apparent depth of objects</i>	RODS+
5	E6a	<i>Refraction of light passing glass-air boundary</i>	RODS
6	E6b	<i>Refraction on glass prism edge</i>	RODS/RODS+
6	E6c	<i>Critical angle, total reflection</i>	RODS
6	E6d	<i>Total reflection – propagating of light in optical fibres</i>	RODS
7	E7	<i>Light ray shift by glass planparallel plate</i>	RODS/RODS+
7	E8	<i>Light ray shift by air planparallel plate</i>	RODS+
7	E9a	<i>Glass prism deviation of light ray</i>	RODS/RODS+
8	E9b	<i>Glass prism minimal deviation</i>	RODS/RODS+
8	E10a	<i>Air prism deviation of light</i>	RODS+
8	E10b	<i>Air prism minimal deviation</i>	RODS+
9	E11a	<i>Reflection of light on one edge of glass prism</i>	RODS+
9	E11b	<i>Reflection of light on two edges of glass prism</i>	RODS+
9	E11c	<i>Reflection of light on two glass prisms</i>	RODS+
10	E11d	<i>Reflection of light on two glass prisms</i>	RODS+
10	E11e	<i>Reflection of light on two glass prisms</i>	RODS+
10	E12	<i>Reflection of light on air prism</i>	RODS+
11	E13a	<i>Light ray passing a concave air – convex glass boundary</i>	RODS+
11	E13b	<i>Light beam passing through concave air – convex glass boundary</i>	RODS+

11	E14a	<i>Light ray passing through convex air – concave glass boundary</i>	RODS+
12	E14b	<i>Light beam passing through convex air – concave glass boundary</i>	RODS+
12	E15a	<i>Light ray passing through concave glass – convex air boundary</i>	RODS+
12	E15b	<i>Light beam passing through concave glass – convex air boundary</i>	RODS+
13	E16a	<i>Light ray tracing passing convex glass – concave air boundary</i>	RODS+
13	E16b	<i>Light beam passing through convex glass – concave air boundary</i>	RODS+
13	E17a	<i>Light beam passing through glass convex lens – beam is parallel to the optical axis</i>	RODS/RODS+
14	E17b	<i>Light beam passing through glass convex lens – the rays are non-parallel to the optical axis</i>	RODS/RODS+
14	E17c	<i>Light beam passing through thick glass convex lens</i>	RODS+
14	E18a	<i>Light beam passing through glass concave lens – the rays are parallel to the optical axis</i>	RODS/RODS+
15	E18b	<i>Light beam passing through glass concave lens – the rays are non-parallel to the optical axis</i>	RODS/RODS+
15	E19a	<i>Light beam passing through air convex lens – the rays are parallel to the optical axis</i>	RODS+
15	E19b	<i>Light beam passing through air convex lens – the rays are non-parallel to the optical axis</i>	RODS+
16	E20a	<i>Light beam passing through air concave lens – the rays are parallel to the optical axis</i>	RODS+
16	E20b	<i>Light beam passing through air concave lens – the rays are non-parallel to the optical axis</i>	RODS+
16	E21a	<i>Parameters of thick lenses – determination of radius of curvature</i>	RODS/RODS+
17	E21b	<i>Parameters of thick lenses – focal length</i>	RODS/RODS+
17	E22a	<i>Model of a normal eye</i>	RODS
17	E22b	<i>Model of short-sighted eye</i>	RODS
18	E22c	<i>Model of long-sighted eye</i>	RODS
18	E23a	<i>Correction of spherical aberration by reducing the beam diameter</i>	RODS/RODS+
18	E23b	<i>Correction of spherical aberration by combination of lenses</i>	RODS
19	E24a	<i>Keplerian telescope</i>	RODS
19	E24b	<i>Galileian telescope</i>	RODS
19	E25	<i>Camera</i>	RODS

RAY OPTICS DEMONSTRATION SETRODS
 RAY OPTICS DEMONSTRATION SET PLUSRODS+

The column „SET TO USE“ informs you which set is appropriate for which experiment (either RODS, or RODS+, or both).

Introduction

The demonstration set RODS was designed for easy and clear demonstration of basic optical effects and devices. Using diode laser as a light source for experiments enables both teacher and student to understand the principle of simple and more complicated optical systems. In this guide book you can find many basic experiments and demonstrations using RODS and RODS+, which is an additional set of optical elements containing air lenses, air prisms etc. Every experiment in this book has three parts:

1. A simple description of the experiment
2. A geometric diagram of the experiment
3. A diagram showing what the experiment looks like when it is set up.

Shown in brackets under the title of the experiment is whether it can be demonstrated with the RODS or RODS+ set, or both. The same note can be found also in the table of contents in the last row. It is clear now, that some experiments cannot be done with RODS and some of them with RODS+.

A very important constituent of the experiments is the LASER RAY BOX which consists of five laser diodes or similar LASER LINE BOX. The box is a model of a beam of parallel rays. Be careful to avoid direct eye contact with the laser beam!

If you have basic set RODS and you are interested in realizing experiments for additional set RODS+, please, contact your distributor of didactic aids.

Table of set elements

RODS, Basic Set

- 1 Biconvex lens Nr. 1
- 2 Biconvex lens Nr. 2
- 3 Biconvex lens Nr. 3
- 4 Biconvex lens Nr. 4
- 5 Biconcave lens Nr. 5
- 6 Planeconvex lens R=45mm
- 7 Planeconvex lens R=75mm
- 8 Planeconcave lens
- 9 Concave mirror
- 10 Convex mirror
- 11 Plane mirror
- 12 Rectangular planparallel plate
- 13 Prism
- 14 Optical fibre

Working sheets

- A Human Eye Model
- B Camera
- C Galileian Telescope
- D Keplerian Telescope
- E Correction of Spherical Aberration
- F Hartle's circle

RODS+, Additional Set

RODS+, Additional Set

- 21 Biconvex air lens (consists of 2 pcs Planconcave glass lenses)
- 22 Biconvex glass lens
- 23 Biconcave air lens (consists of 2 pcs Planconvex glass lenses)
- 24 Biconcave glass lens
- 25 Equilateral optical air prism
- 26 Equilateral optical glass prism
- 27 Rectangular optical glass prism (2 pcs)
- 28 Square glass planparallel plate
- 29 Rectangular glass planparallel plate (2 pcs)
- 11 Plane mirror (2 pcs)

E1 Reflection on plane mirror
 (RODS/RODS+)

The law of reflection is demonstrated. When a light ray impinges a plane mirror under an angle α , it is reflected under the same angle β

$$\alpha = \beta$$

Both angles are measured from the perpendicular line to the mirror plane.

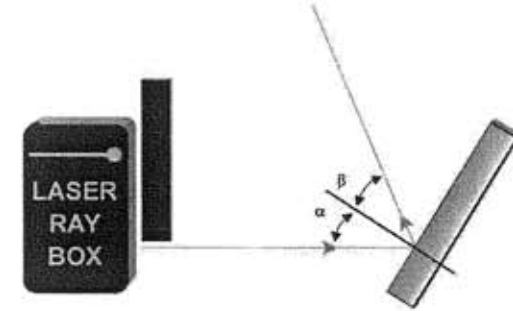
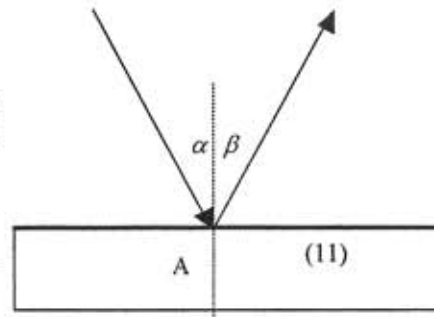

E2 Reflection on two plane mirrors
 (RODS+)

An interesting relation can be shown:

$$\delta = 2\gamma$$

where δ is the angle between the incident and the reflected ray and γ is the angle between the mirrors' planes.

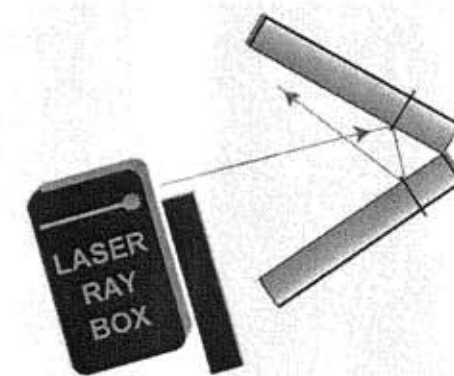
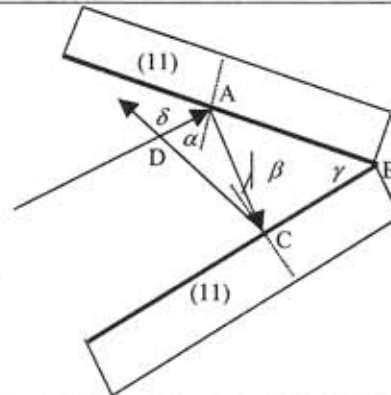

E3a Reflection of light rays on concave mirror – rays are parallel to optical axis
 (RODS)

The focal length f of the concave mirror is determined by the length of the line VF. The curvature radius can be obtained using the known formula:

$$r = 2f$$

The distance of the centre of curvature S is twice as long as the distance of the focus F.

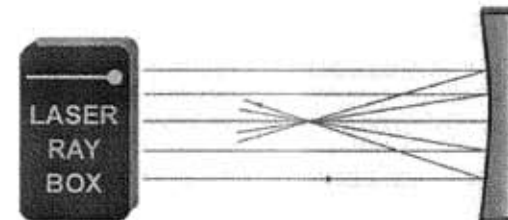
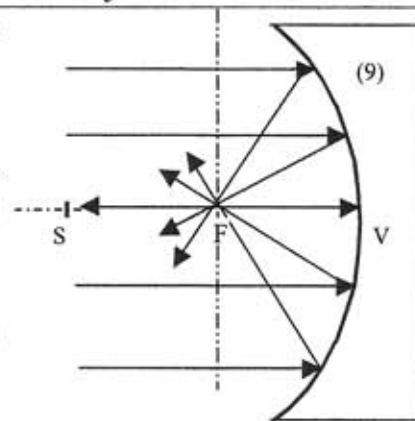

E3b Reflection of light rays on concave mirror – rays are non-parallel to optical axis
 (RODS)

The axis φ which is perpendicular to the optical axis and passes through the focus is referred as the **focal plane** of the concave mirror. If the parallel rays impinge the mirror, they meet at one point of the axis φ after the reflection. In the case of the rays parallel to the optical axis, the point belongs to the axis and is called the **focus (F)**.

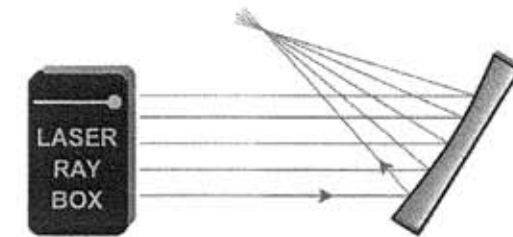
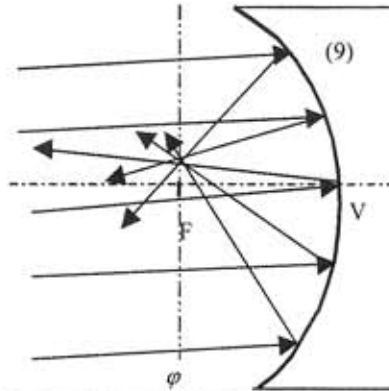

E4a Reflection of light rays on convex mirror – rays are parallel to optical axis
 (RODS)

If rays, which are parallel to the optical axis impinge the mirror, the reflected rays appear to start from one point on the right side behind the mirror. This point is referred to as the **figure focus**. The length of line VF determines the focal length f of the mirror. The radius of curvature can be obtained from the next formula.

$$r = 2f$$

The distance of the **centre of curvature S** is two times longer than the distance of the **focus F**.

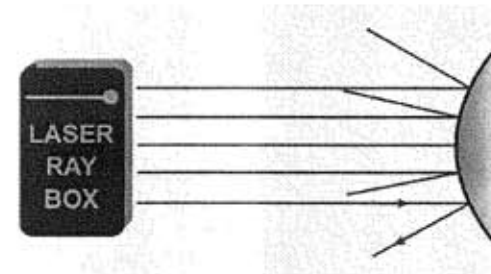
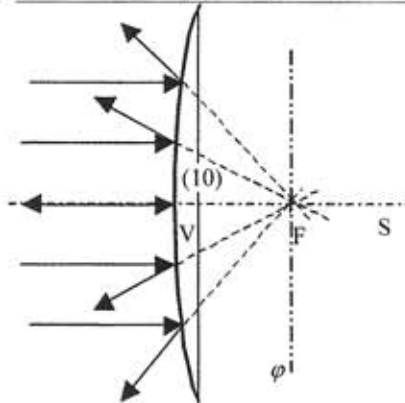

E4b Reflection of light rays on convex mirror – rays are non-parallel to optical axis
 (RODS)

The axis φ which is perpendicular to the optical axis and passes through the focus is referred to as the **focal plane** of the convex mirror. If parallel rays impinge the mirror, they are scattered in such a way that they appear to start from one point of the plane φ . In the case of incidence rays parallel to the optical axis this point belongs to the axis.

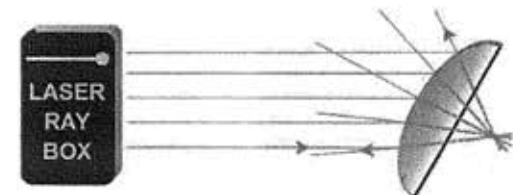
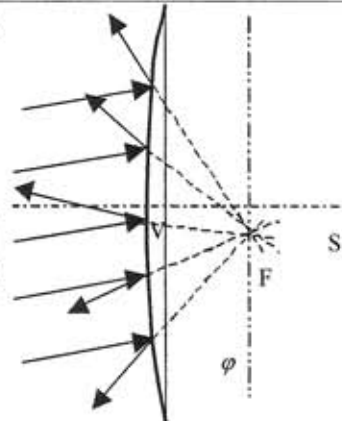

E5a Refraction of light passing air-glass boundary
 (RODS, Working sheet F)

If light passes through one optical medium characterized by refraction index n_1 into the other with refraction index n_2 its direction is changed by the **Snell law**

$$n_1 \sin \alpha = n_2 \sin \beta$$

where α is an incidence angle in the medium n_1 and β is an angle of refraction in the medium n_2 . The angles are measured from the normal to the planar boundary.

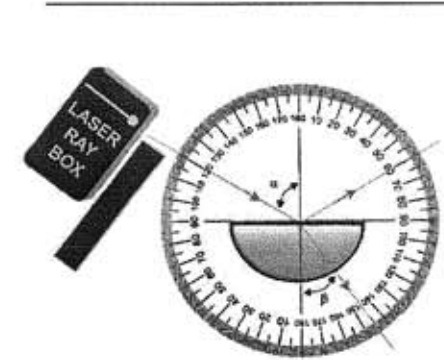
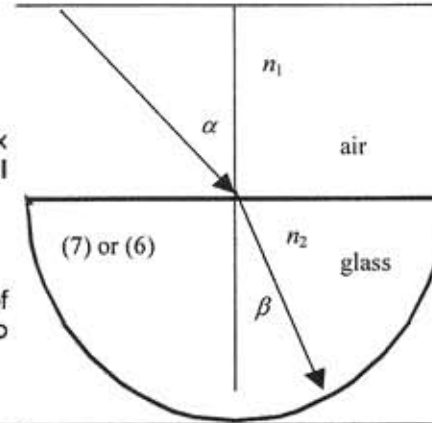

E5b Apparent depth of objects
 (RODS+)

You can build up the model of observing the depth of objects in water or glass from air. The real length of the object is h and the unreal length is h_1 .

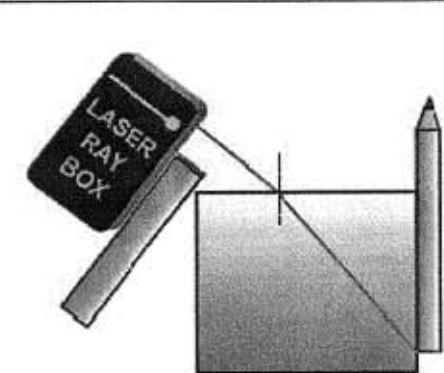
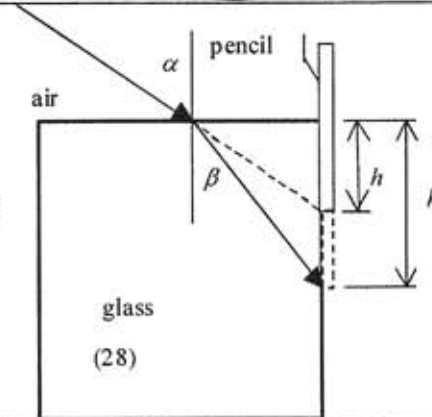

E6a Refraction of light passing glass-air boundary
 (RODS, Working sheet F)

The ray is refracted with the refraction angle β , which is larger than α . The ray is bent away from the normal.

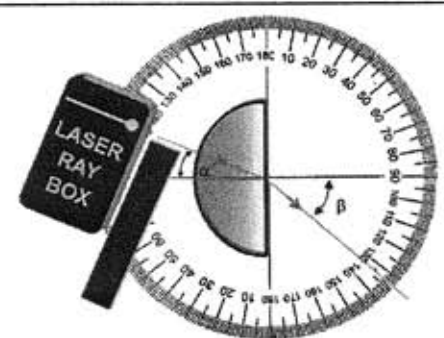
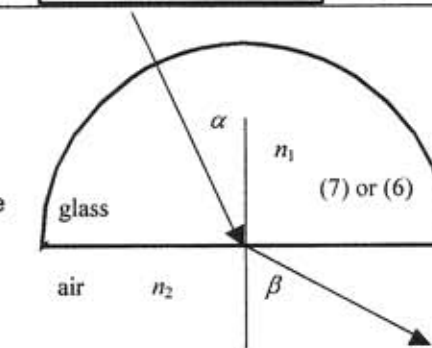

E6b Refraction on glass prism edge
 (RODS)

When light passes through glass to air, the Snell law can be written in the next form:

$$n_1 \sin \alpha = \sin \beta$$

Refractive index of air $n_2 = 1$.

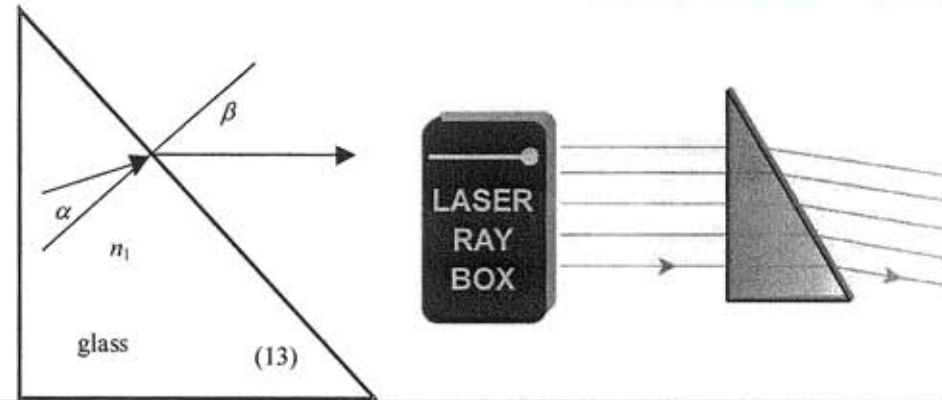

E6c Critical angle, total reflection
 (RODS, Working sheet F)

The larger the incidence angle the larger the refraction angle. If $n_1 > n_2$ a **critical angle** α exists, when $\beta = 90^\circ$. In other words, the refracted ray lies on the border of two mediums. When the incidence angle is larger than the critical angle, there is no more refracted light and all light energy is reflected, this is called **total reflection**.

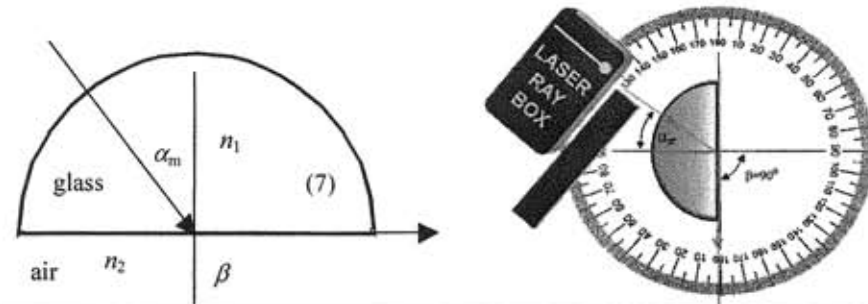

E6d Total reflection – propagating of light in optical fibres
 (RODS)

If light enters the optical fibre from the medium with refractive index n under some angles it propagates in it using the total reflection on the borders of the fibre. These angles have to be smaller than acceptance angle Θ_{\max} . It is characterized by parameter - the **numerical aperture (NA)**. It is given by relation

$$NA = n \sin \Theta_{\max} = \sqrt{n_1^2 - n_2^2}$$

where n_1 is the refractive index of the fibre core and n_2 is the refractive index of the cladding. Also the minimal radius of the fibre bent is set by NA. It cannot be smaller, when the fibre is installed.

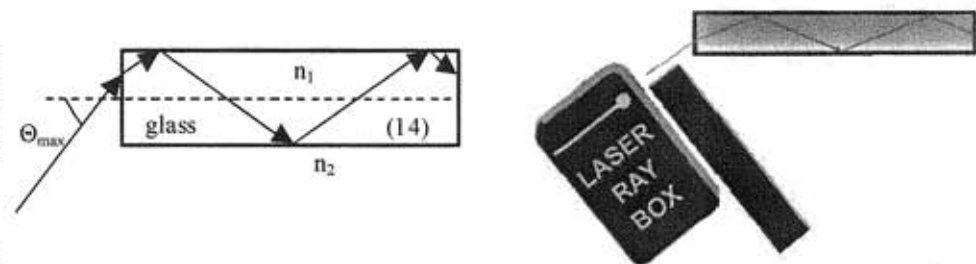

E7 Light ray shift by glass planparallel plate
 (RODS/RODS+)

If a light ray passes through a planparallel plate its **direction is not changed**. The outgoing ray is **shifted** in accordance with the incoming one. The shift d can be estimated with respect to the thickness h of the plate using the formula:

$$d = h \frac{\sin(\alpha - \beta)}{\cos \beta}$$

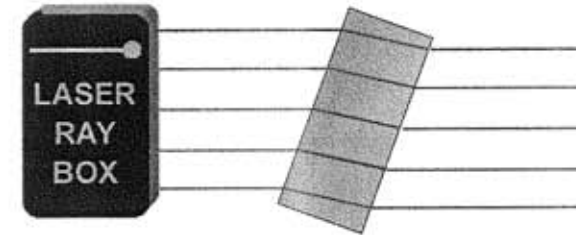
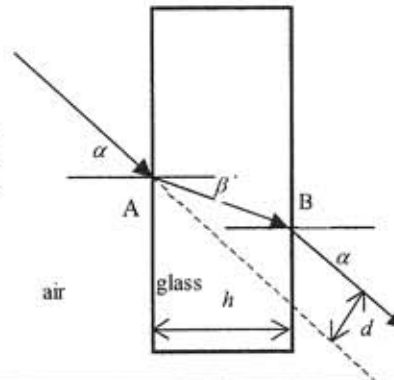

E8 Light ray shift by air planparallel plate
 (RODS+)

In this case a shift between the incoming and the outgoing ray can be observed. This shift has an opposite direction than in the case of the glass plate.

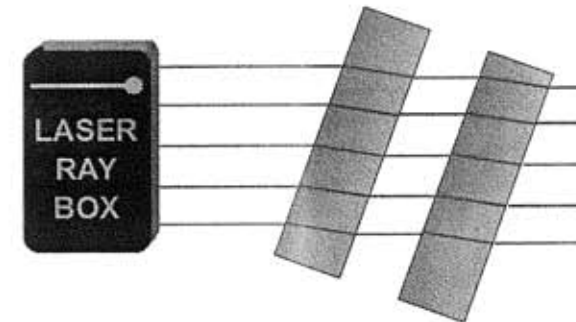
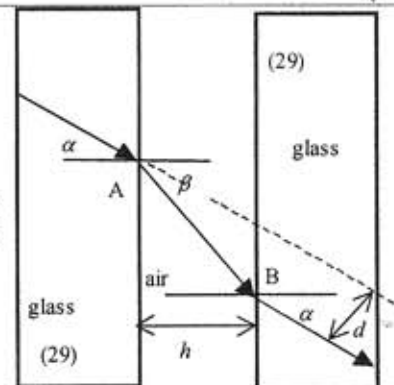

E9a Glass prism deviation of light ray
 (RODS/RODS+)

If the prism is glass, after the light impinges the point A, it is bent toward the normal and refracts to point B. At this point it is bent into the air away from the normal. The sum of all refraction angles is the **deviation angle** δ . It is the angle between the incidence and the outgoing ray.

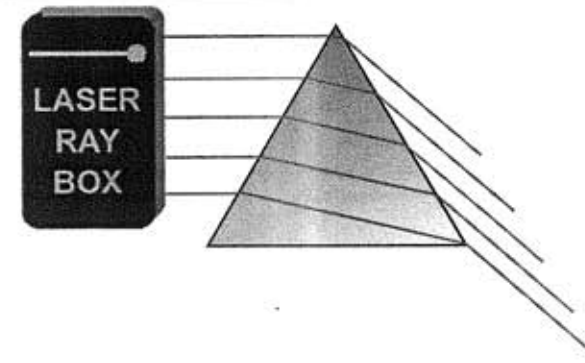
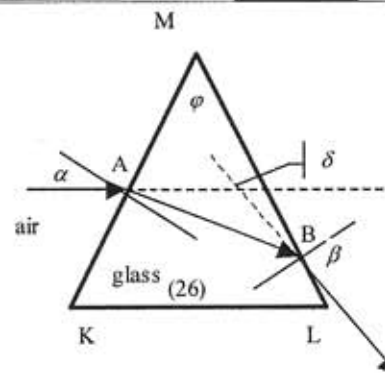

E9b Glass prism minimal deviation
 (RODS/RODS+)

It can be seen that in the case of minimal deviation δ_{\min} the incidence angle is equal to the angle of the outgoing ray. The direction of the refraction of light in the prism is parallel to the edge the ray does not pass through. The refractive index of the prism obeys the formula:

$$n = \frac{\sin \frac{\delta_{\min} + \varphi}{2}}{\sin \frac{\varphi}{2}}$$

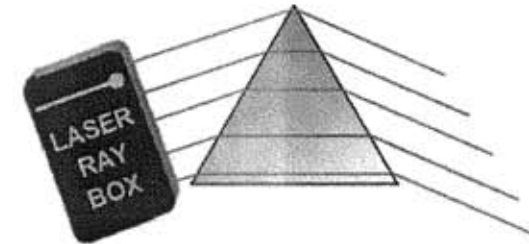
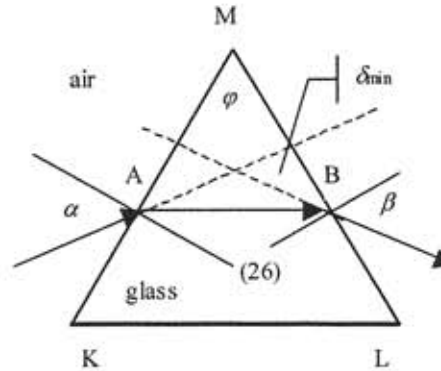

E10a Air prism deviation of light
 (RODS+)

Light passes through the glass-air border at point A. Then it is directed away from the normal axis and after light passes through point B, it is then directed toward the normal. The sum of the refraction angles is referred as the **deviation angle** δ . It is the angle between the incidence and the outgoing ray.

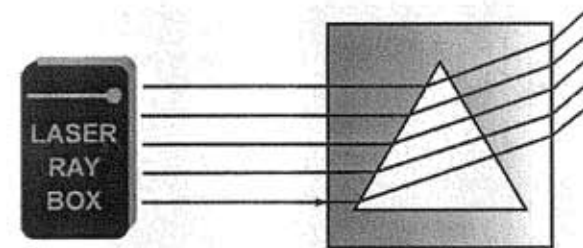
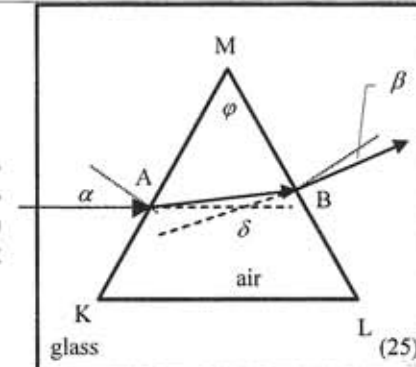

E10b Air prism minimal deviation
 (RODS+)

In the case of minimal deviation δ_{\min} the incidence angle is equal to the angle of the outgoing ray. The direction of the refracted light in the prism is parallel to the edge the ray does not pass through. The refractive index of the prism obey formula (see E9b). The deviation has an opposite direction as in the case of a glass prism.

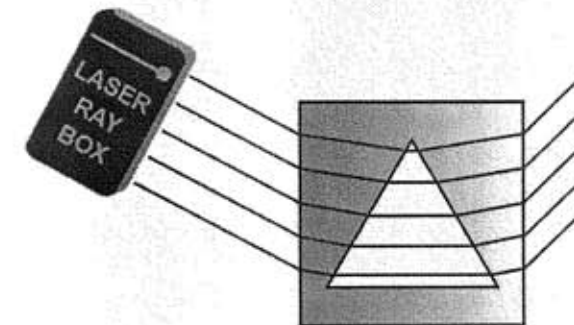
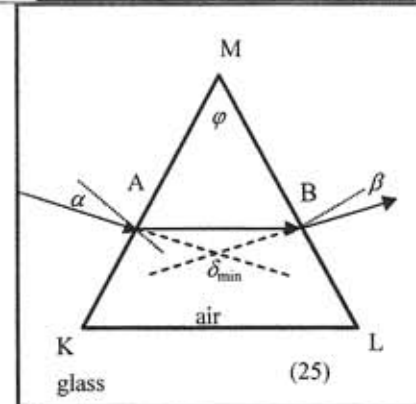

E11a Reflection of light on one edge of glass prism (RODS+)

When the rays impinge the edge, they are totally reflected. If the prism is slightly adjusted reflection and refraction can be observed.

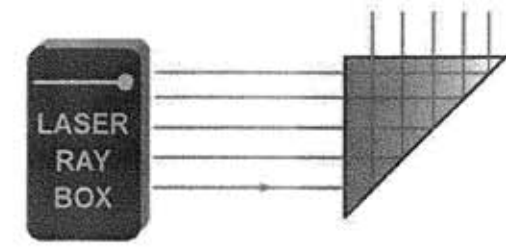
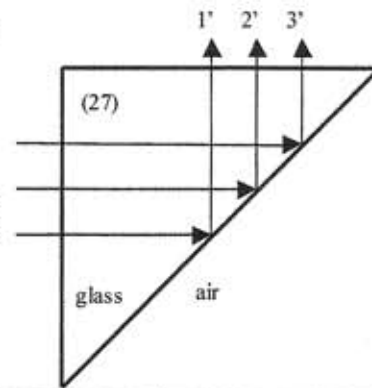

E11b Reflection of light on two edges of glass prism (RODS+)

The conditions for total reflections are fulfilled on both edges of the prism. If the top ray of the incidence light is eliminated, the bottom ray of the outgoing light disappears. The picture is 180° rotated.

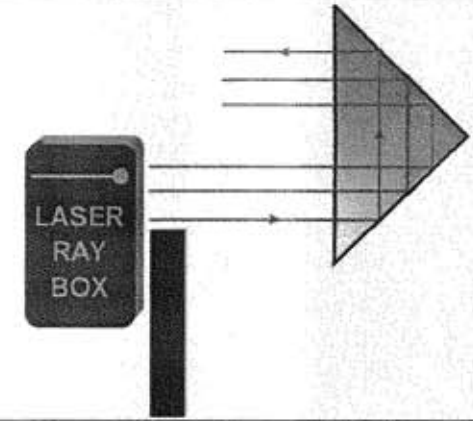
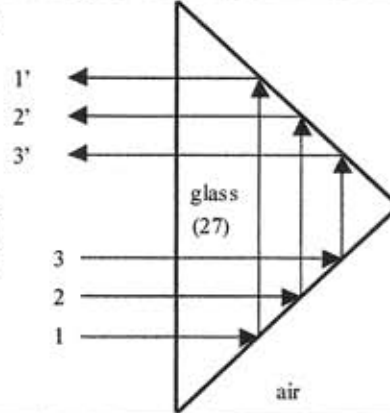

E11c Reflection of light on two glass prisms (RODS+)

Conditions for total reflection are fulfilled on every edge.

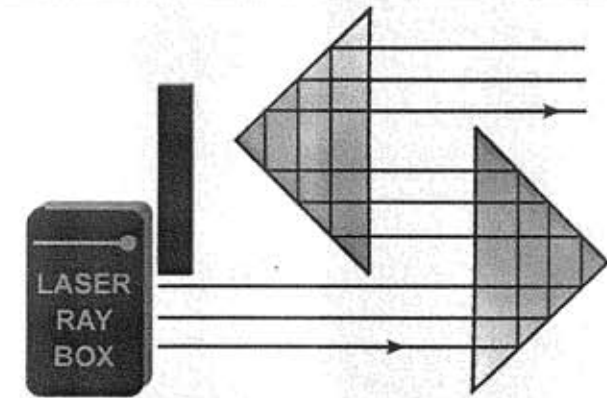
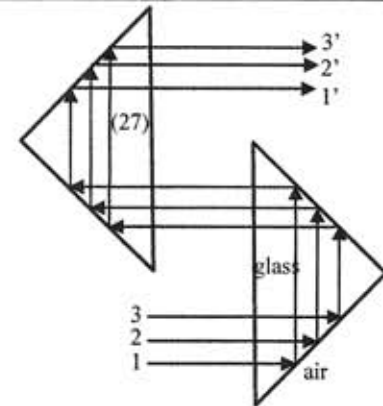

E11d Reflection of light on two glass prisms
 (RODS+)

Conditions necessary for total reflection are fulfilled on every edge.

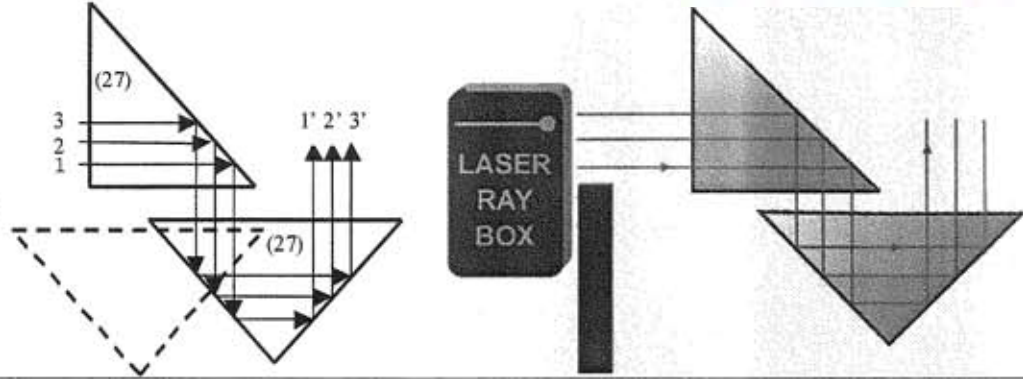

E11e Reflection of light on two glass prisms
 (RODS+)

Conditions necessary for total reflection are fulfilled on every edge.

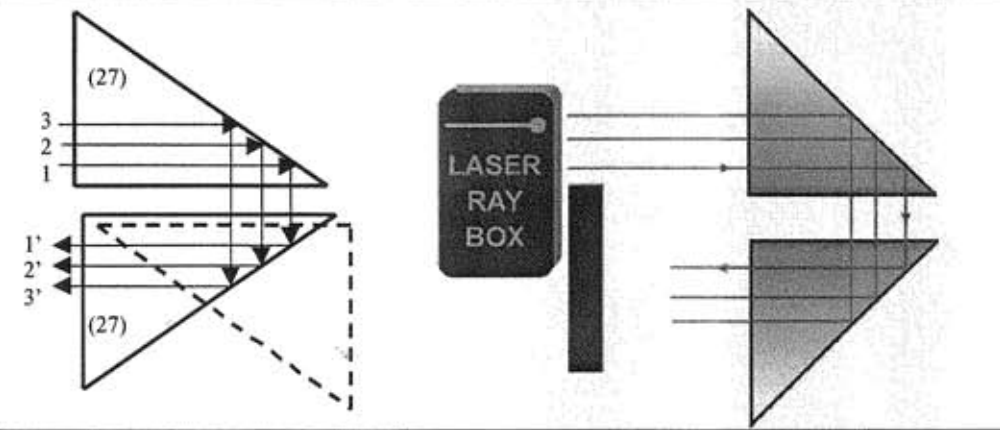

E12 Reflection of light on air prism
 (RODS+)

If the incidence angle of light to the edge of the prism (25) is smaller than critical angle (42 °), the rays are reflected into the glass. If the angle is greater, a part of the light passes through the air prism.

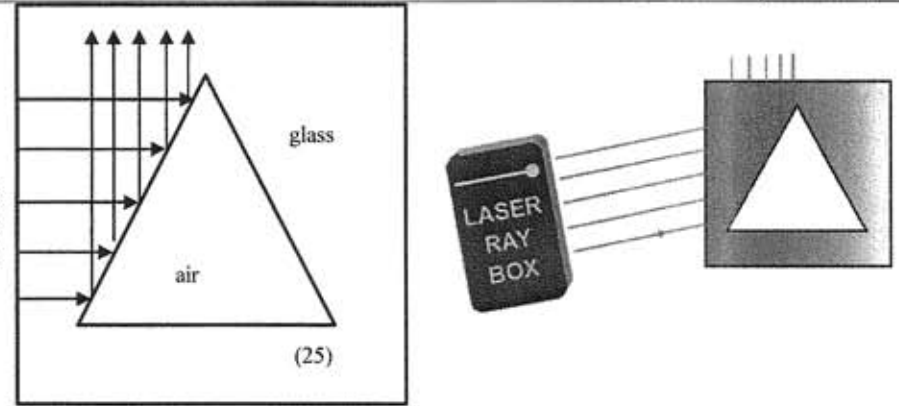

E13a Light ray passing a concave air – convex glass boundary
 (RODS+)

When a ray impinges the air-glass boundary at point A, it is directed toward the normal. The normal is defined as the line from point A to the centre of boundary curvature S.

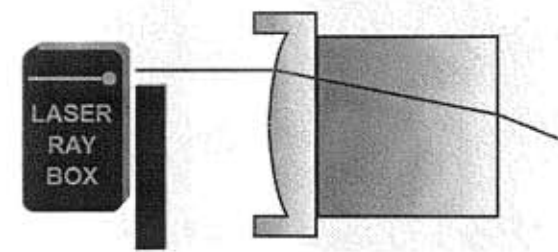
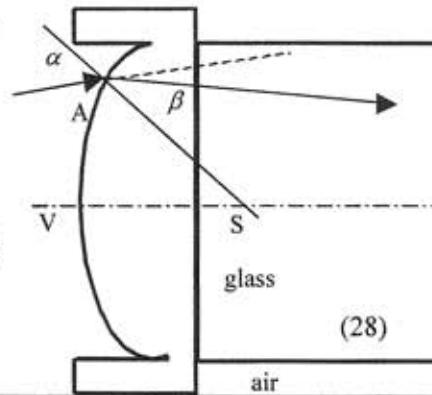

E13b Light beam passing through concave air – convex glass boundary
 (RODS+)

Using a boundary of convenient curvature radius and an auxiliary glass element, where the rays are refracted, one can observe that the rays are met at the point F' in the optical axis – figure focus..

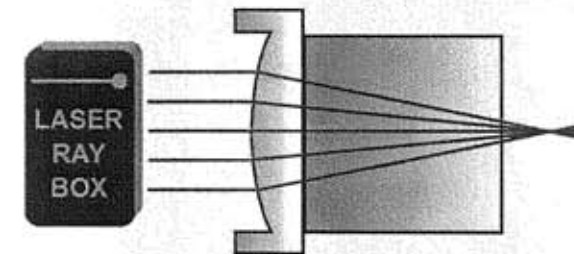
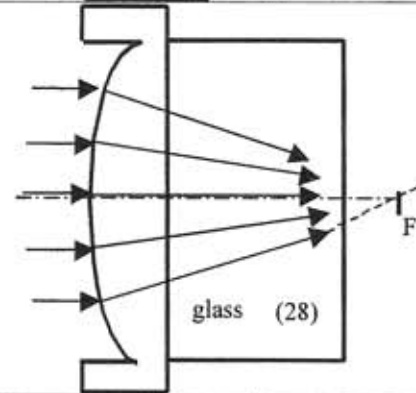

E14a Light ray passing through convex air – concave glass boundary
 (RODS+)

When a ray impinges the boundary at point A, refraction towards the normal is observed. The normal is defined as the line from point A to the centre of boundary curvature S.

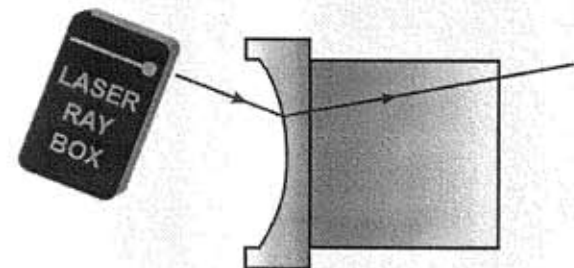
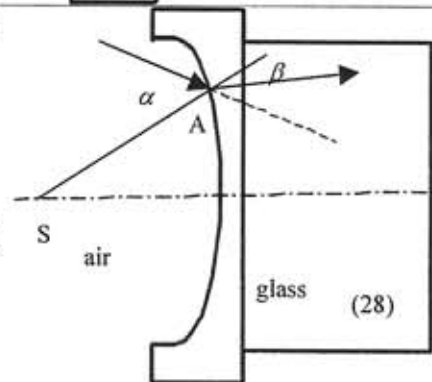

E14b Light beam passing through convex air – concave glass boundary
 (RODS+)

The beam after passing the boundary is divergent. Elongating the refracted light to the other side one can find a point on the optical axis where the line meets. It is **figure focus F'**.

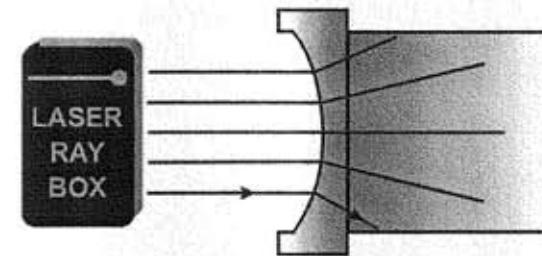
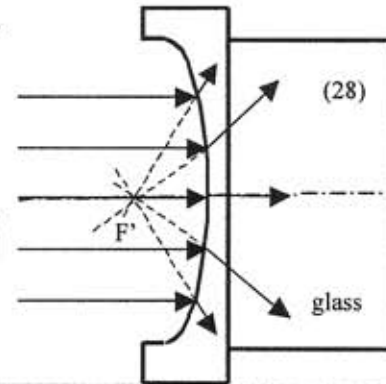

E15a Light ray passing through concave glass – convex air boundary
 (RODS+)

When a ray impinges the boundary at point A, refraction away from the normal is observed. The normal can be defined as the line from point A to the centre of boundary curvature S.

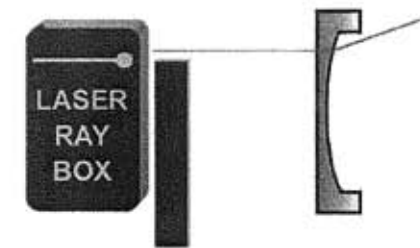
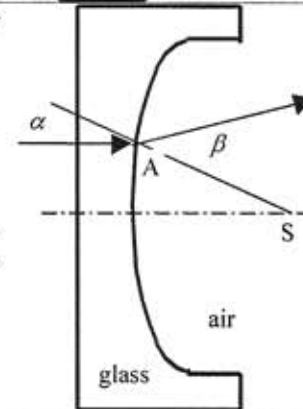

E15b Light beam passing through concave glass – convex air boundary
 (RODS+)

The beam after passing the boundary is divergent. Elongating the refracted light to the other side one can find a point on the optical axis where the line meets. It is **figure focus F'**.

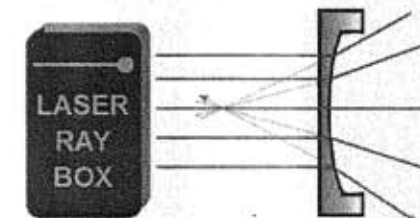
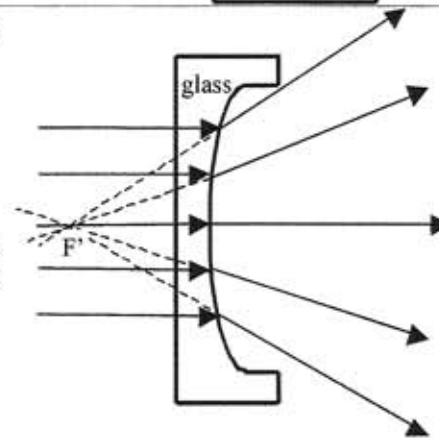

E16a Light ray passing through convex glass – concave air boundary (RODS+)

When a ray impinges the boundary at point A, refraction away from the normal is observed. The normal is defined as the line from point A to the centre of boundary curvature S.

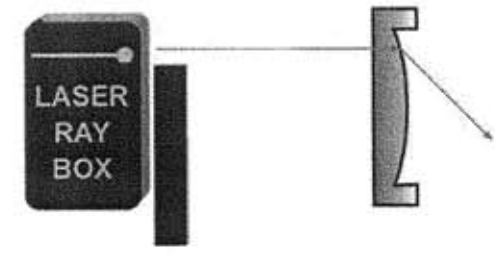
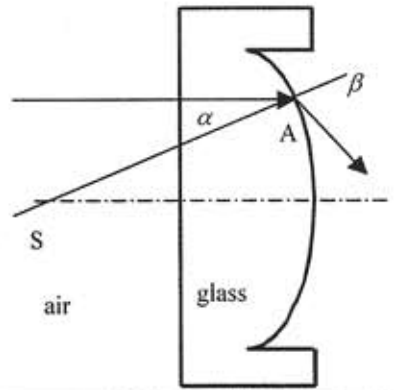

E16b Light beam passing through convex glass – concave air boundary (RODS+)

The beam is convergent after passing the boundary. Parallel rays meet in one point of the optical axis – figure focus F'.

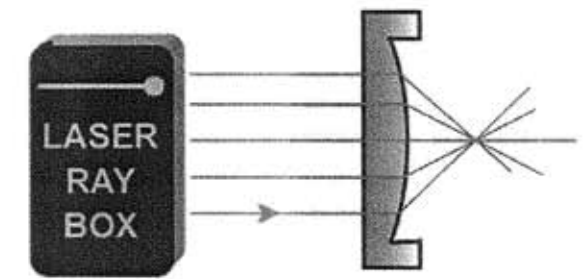
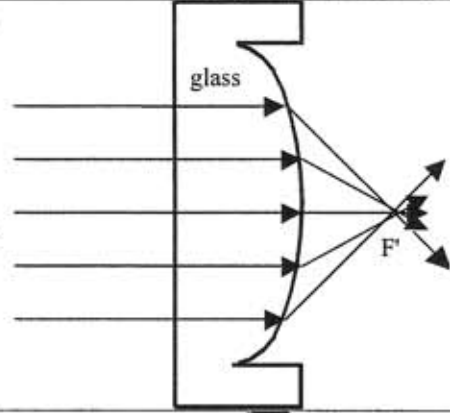

E17a Light beam passing through glass convex lens – beam is parallel to the optical axis (RODS/RODS+)

A convex glass lens behaves as a convergent optical system and the rays meet at figure focus F' after passing through the lens.

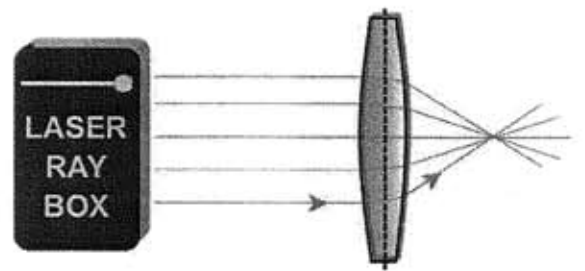
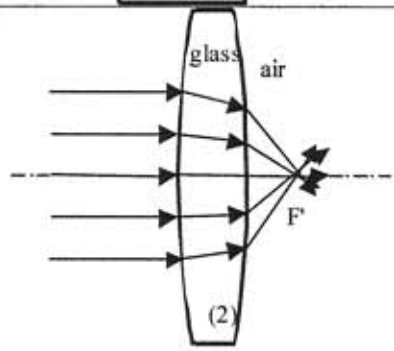

E17b Light beam passing through glass convex lens – the rays are non-parallel to the optical axis
 (RODS/RODS+)

The plane φ' which is perpendicular to the optical axis, combined with the figure focus F' is called a **figure focus plane**. If a beam of parallel rays impinges the convex glass lens, the refracted rays cross the plane φ' at one point.

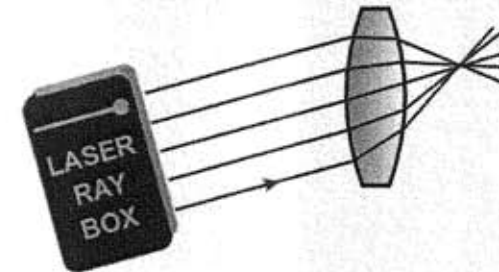
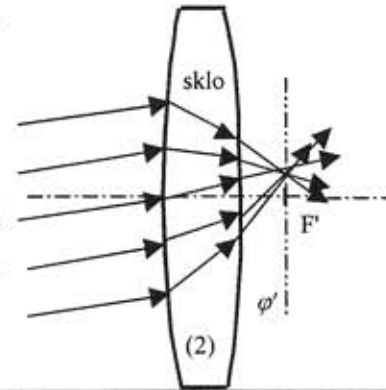

E17c Light beam passing through thick glass convex lens
 (RODS+)

By inserting planparallel plates into the space between two elements (23), a model of a thick lens can be constructed. The thickness d of the lens can be changed. If the thickness increases the focal length of the lens decreases. For a critical thickness the lens changes from convergent to divergent.

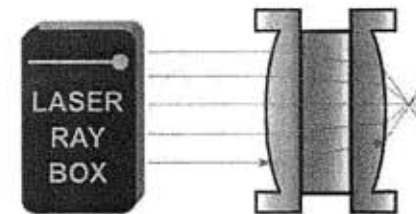
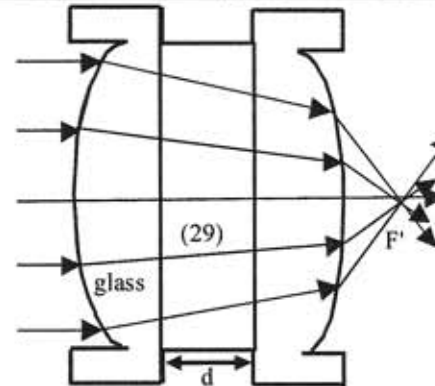

E18a Light beam passing through glass concave lens – the rays are parallel to the optical axis
 (RODS/RODS+)

The rays are divergent after passing a concave glass lens, they do not create a real figure. By elongating the rays it is seen that the lines have a common intersection – **figure focus F'** .

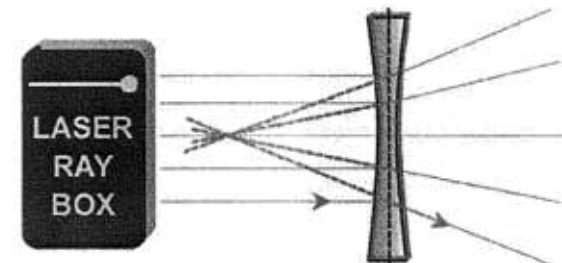
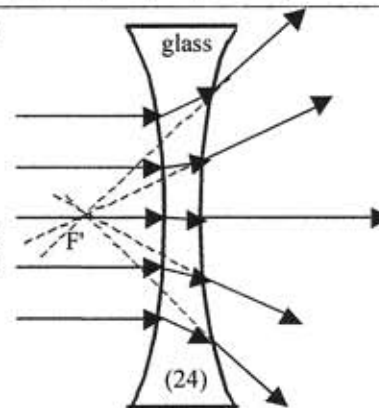

E18b Light beam passing through glass concave lens – the rays are non-parallel to the optical axis (RODS/RODS+)

The plane φ' which is perpendicular to the optical axis, combined with the figure focus F' is called a **figure focus plane**. If a beam of parallel rays impinges the concave glass lens, the elongated lines of the refracted rays cross the plane φ' at one point.

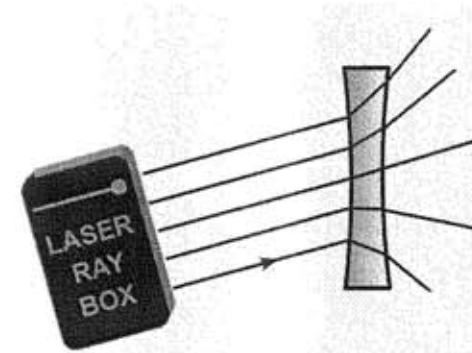
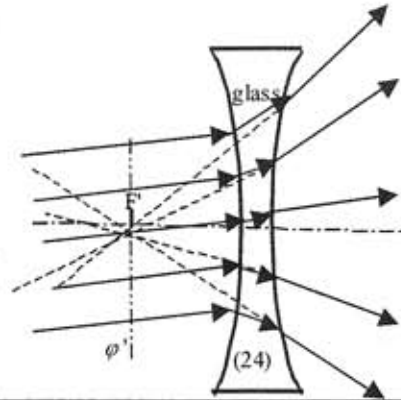

E19a Light beam passing through air convex lens – the rays are parallel to the optical axis (RODS+)

The rays are divergent after passing a convex air lens, they do not create a real figure. By elongating the rays one can see the lines has a common intersection – **figure focus F'** .

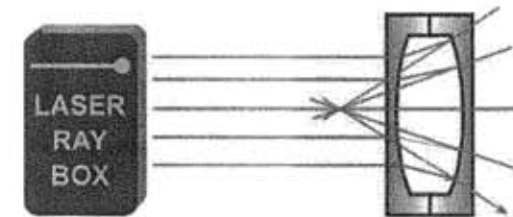
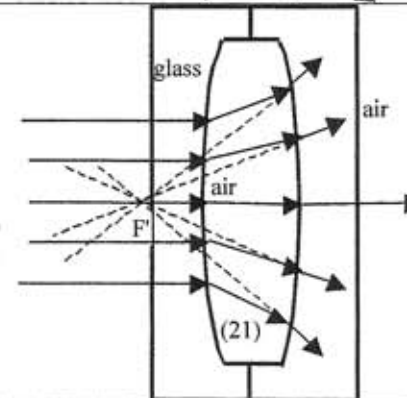

E19b Light beam passing through air convex lens – the rays are non-parallel to the optical axis (RODS+)

The plane φ' which is perpendicular to the optical axis, combined with the figure focus F' is called a **figure focus plane**. If a beam of parallel rays impinges the convex air lens, the elongated lines of the refracted rays cross the plane φ' at one point.

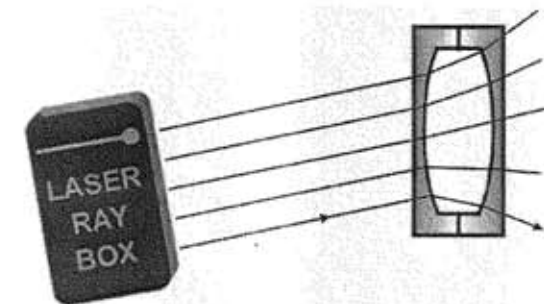
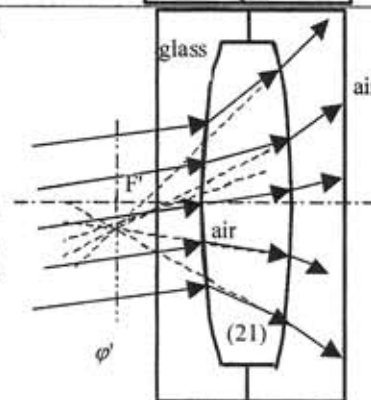

E20a Light beam passing through air concave lens – the rays are parallel to the optical axis (RODS+)

A concave air lens behaves as a **convergent optical system** and the rays meet at figure focus F' after passing through the lens.

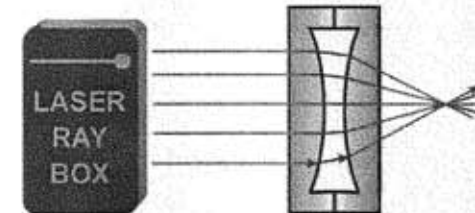
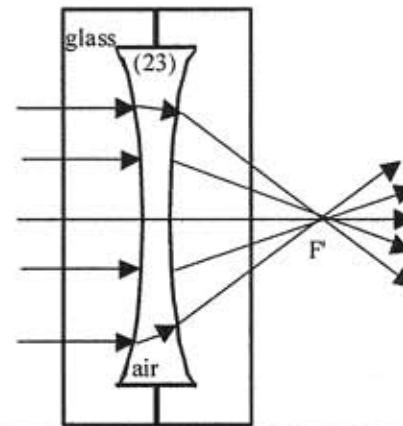

E20b Light beam passing through air concave lens – the rays are non-parallel to the optical axis (RODS+)

The plane φ' which is perpendicular to the optical axis, combined with figure focus F' is called a **figure focus plane**. If a beam of parallel rays impinges the concave air lens, the refracted rays cross the plane φ' at one point.

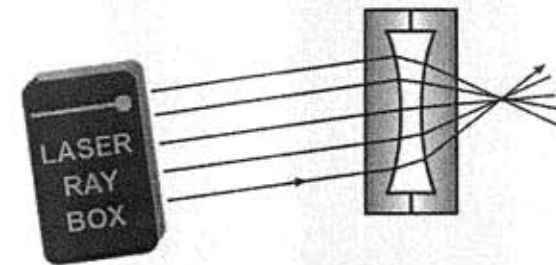
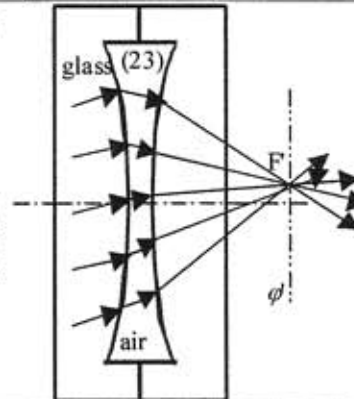

E21a Parameters of thick lenses – determination of radius of curvature (RODS/RODS+)

The lenses in the set have **cylindrical refraction surfaces with circular bottoms** with equal radii of curvature. You can measure these radii by using a millimetre grid.

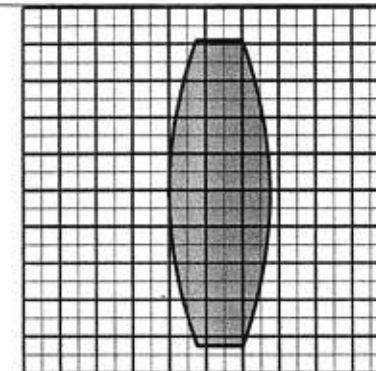
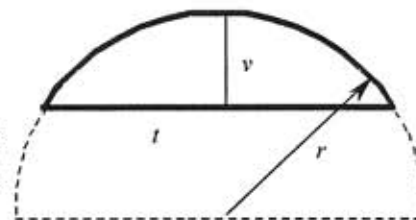

E21b Parameters of thick lenses – focal length
 (RODS/RODS+)

In the case of a **thick lens** (a lens with not negligible thickness) the definition of the focal length as a distance of the focus from the main planes (points – H and H'), must be taken into account.

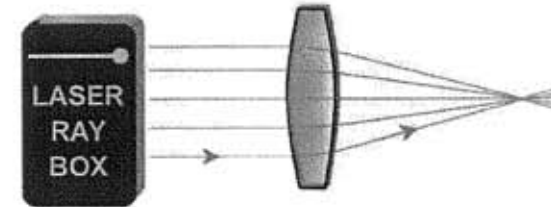
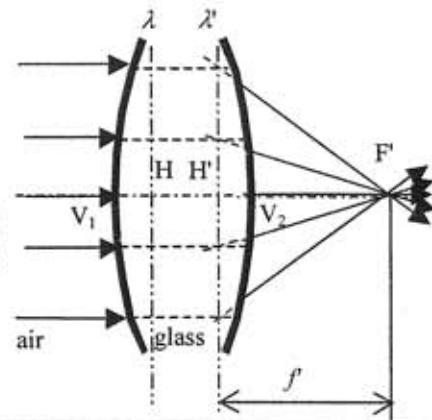

E22a Model of a normal eye
 (RODS, Working sheet A)

Display rays parallel to the optical axis intersect after passing through uncorrected eye lens at one point of the retina. Place the eye lens (1) directly behind the line O₂.

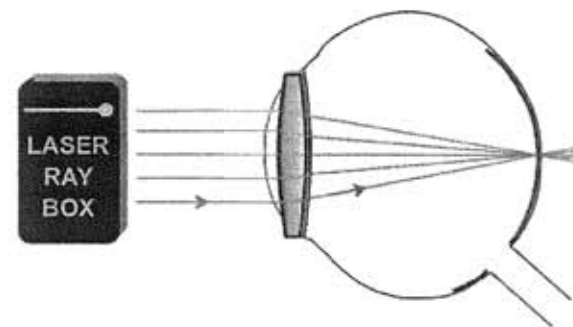
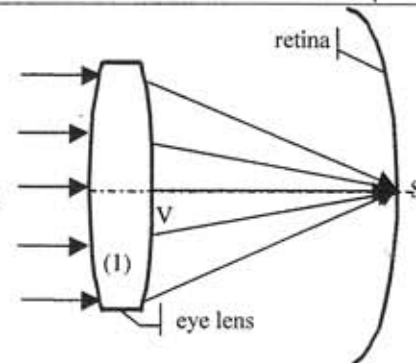

E22b Model of short-sighted eye
 (RODS, Working sheet A)

Display rays parallel to the optical axis intersect after passing through uncorrected eye lens at one point of the optical axis before the retina. Place the eye lens (2) directly behind the line O₂ and the correction lens (5) between the lines O₁ and O₂.

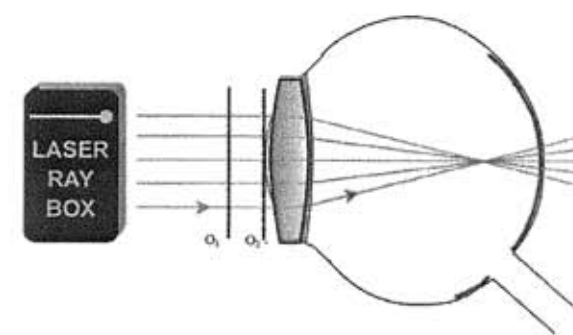
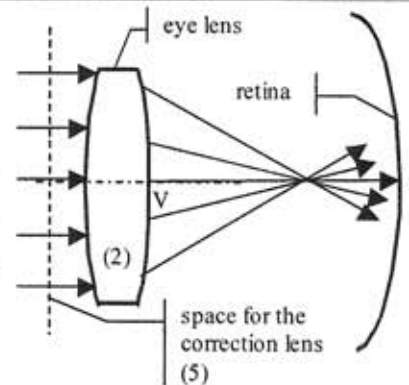

E22c Model of long-sighted eye
 (RODS, Working sheet A)

Display rays parallel to the optical axis intersect after passing through uncorrected eye lens at one point of the optical axis after the retina. A correction lens must be convergent. The focal length f' of the system of eye lens and the correction lens is

$$f' = \frac{f_1' f_2'}{f_1' + f_2'}$$

where f_1' is the focal length of the eye lens and f_2' is the focal length of the correction lens.

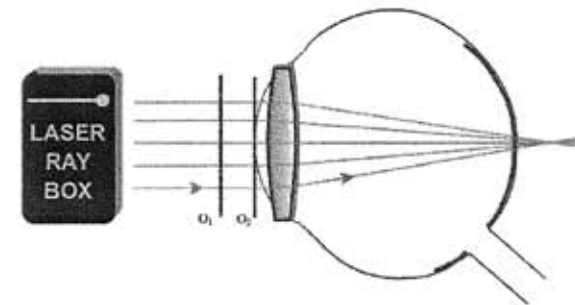
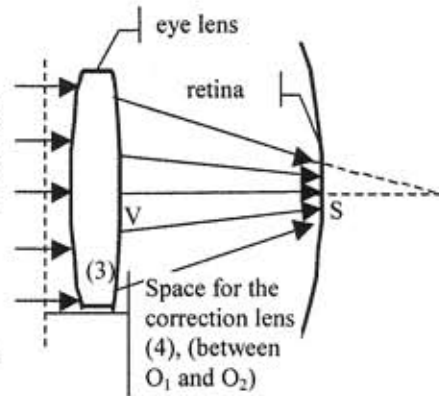

E23a Correction of spherical aberration by reducing the beam diameter
 (RODS/RODS+)

Spherical aberration of a lens can be reduced by reducing the diameter of the beam which impinges the lens. The rays which are far away from the optical axis must be obscured.

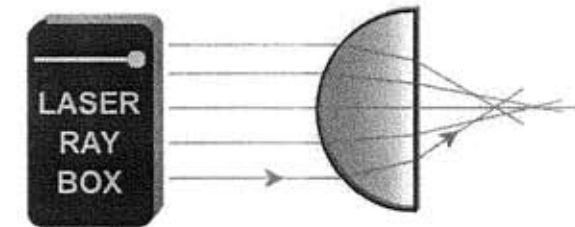
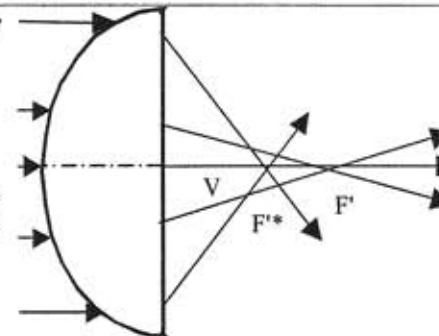

E23b Correction of spherical aberration by combination of lenses
 (RODS, Working sheet E)

The spherical aberrations of divergent and convergent lenses have an inverse effect. By a convenient combination of these two types of lenses the aberration can be corrected. The aberration $\Delta f' = f'' - f'$ is defined as the difference between the focal length f'' of marginal beam rays and the focal length f' of paraxial rays. In the case of a convergent lens the aberration is of a plus sign and for a divergent lens it is a minus sign.

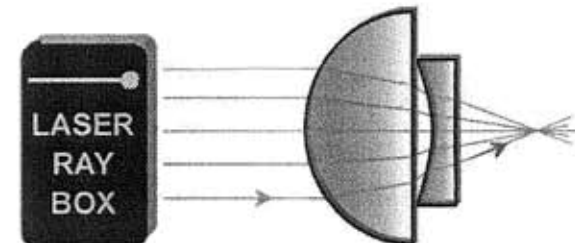
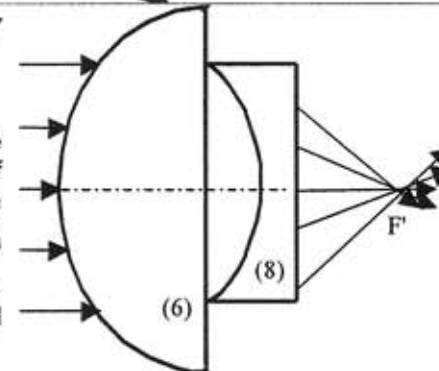

E24a Keplerian telescope
 (RODS, Working sheet D)

The figure from Kepler's telescope is reversed. This can be verified by obscuring a marginal ray. One can see that if the top ray is obscured, in the output ray the bottom ray disappears. The figure is unreal and magnified.

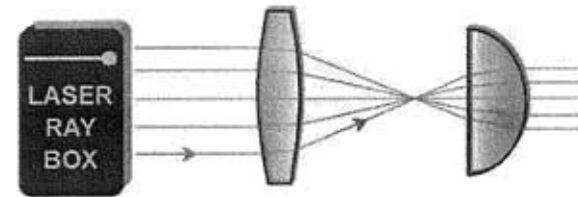
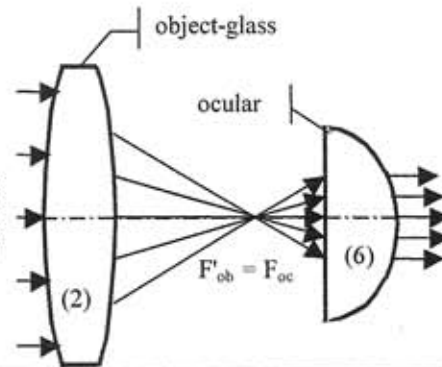

E24b Galileian telescope
 (RODS, Working sheet C)

In this experiment the incident angle can be changed. The larger change of the output angle is observed (the viewing angle is magnified – the figure is magnified). The figure is created by parallel rays, so it is unreal and magnified. If the top ray of the incident beam is obscured, the top ray of the output beam disappears.

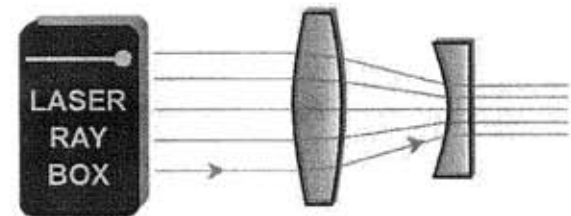
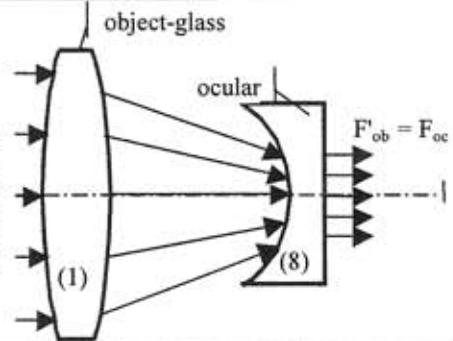

E25 Camera
 (RODS, Working sheet B)

The lens of the camera is a convergent optical system. The figure which appears on the rear part of the camera is real and reversed. It is directed onto the optical material.

