

**Instruction Manual and  
Experiment Guide for the  
PASCO scientific  
Model ME-8930**

012-06734A

09/98

# SMART TIMER

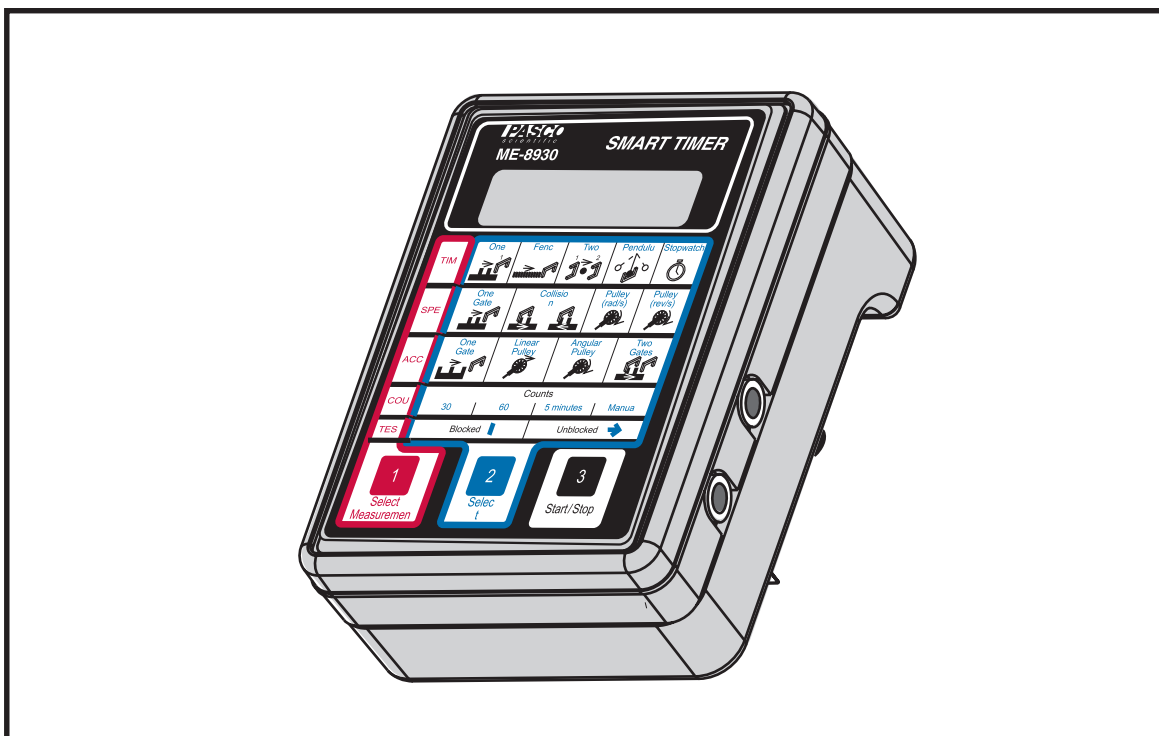

© 1998 PASCO scientific

\$7.50



# Table of Contents

<b>Section</b>	<b>Page</b>
Table of Contents .....	i
Copyright, Warranty, and Equipment Return .....	ii
Introduction .....	1
Equipment .....	3
Operating the Smart Timer .....	4
Smart Timer Modes of Operation .....	4
Quick Cross-Reference for Suggested Activities and Smart Timer Modes .....	5
Time Modes .....	6
Speed Measurement Modes .....	7
Table 1: Summary of Timing Modes .....	8–9
Acceleration Measurement Modes .....	10
Count Modes .....	10
Test Mode .....	11
Timing Diagrams .....	11
LOCK Switch: .....	11
Caring for the Smart Timer .....	12
Specifications .....	12
Accessory Options .....	12
Troubleshooting .....	14
Experiment One: Acceleration of Gravity .....	15
Experiment Two: Newton’s Second Law .....	17
Experiment Three: Conservation of Momentum In Collisions .....	19
Experiment Four: Conservation of Angular Momentum .....	25
Other Suggested Experiments .....	31
Technical Support .....	back cover

# Copyright, Warranty, and Equipment Return

**Please**—Feel free to duplicate this manual subject to the copyright restrictions below.

## Copyright Notice

The PASCO scientific 012-06734A Smart Timer manual is copyrighted and all rights reserved. However, permission is granted to non-profit educational institutions for reproduction of any part of the manual providing the reproductions are used only for their laboratories and are not sold for profit. Reproduction under any other circumstances, without the written consent of PASCO scientific, is prohibited.

## Limited Warranty

PASCO scientific warrants the product to be free from defects in materials and workmanship for a period of one year from the date of shipment to the customer. PASCO will repair or replace at its option any part of the product which is deemed to be defective in material or workmanship. The warranty does not cover damage to the product caused by abuse or improper use. Determination of whether a product failure is the result of a manufacturing defect or improper use by the customer shall be made solely by PASCO scientific. Responsibility for the return of equipment for warranty repair belongs to the customer. Equipment must be properly packed to prevent damage and shipped postage or freight prepaid. (Damage caused by improper packing of the equipment for return shipment will not be covered by the warranty.) Shipping costs for returning the equipment after repair will be paid by PASCO scientific.

## Equipment Return

Should the product have to be returned to PASCO scientific for any reason, notify PASCO scientific by letter, phone, or fax BEFORE returning the product. Upon notification, the return authorization and shipping instructions will be promptly issued.

► **NOTE:** NO EQUIPMENT WILL BE ACCEPTED FOR RETURN WITHOUT AN AUTHORIZATION FROM PASCO.

When returning equipment for repair, the units must be packed properly. Carriers will not accept responsibility for damage caused by improper packing. To be certain the unit will not be damaged in shipment, observe the following rules:

- ① The packing carton must be strong enough for the item shipped.
- ② Make certain there are at least two inches of packing material between any point on the apparatus and the inside walls of the carton.
- ③ Make certain that the packing material cannot shift in the box or become compressed, allowing the instrument come in contact with the packing carton.

Address: PASCO scientific  
10101 Foothills Blvd.  
Roseville, CA 95747-7100

Phone: (916) 786-3800  
FAX: (916) 786-3292  
email: techsupp@pasco.com  
web: www.pasco.com

---

## Introduction

The PASCO ME-8930 Smart Timer is an accurate, versatile digital timer and measurement system for the student laboratory. The Smart Timer offers 0.1 ms timing resolution and an easy-to-use memory function. The Smart Timer measures several types of events detected with PASCO's digital sensors, including speed and acceleration using standard photogates. The PASCO ME-9387 Smart Pulley, the ME-9207B Free Fall Adapter, the ME-6810 Time-of-Flight Accessory, or the ME-9259A Laser Switch also work with the Smart Timer. The Smart Timer counts radiation emission events detected with the SN-7927 G-M Tube/Power Supply or the SE-7997 G-M Tube. The Smart Timer features two input channels and a 2-line, 16-character alphanumeric liquid crystal display that indicates the operating mode and experimental results.

### ***Features:***

The Smart Timer's memory function makes it easy to time events that happen in rapid succession, such as a Dynamics Cart passing twice through the photogate, once before and then again after a collision. The 0.1 ms resolution is especially useful in some experiments, such as measuring velocity or acceleration during free fall. The Smart Timer can calculate velocity before and after a collision between two carts using a single timer. With the new fence design and sensing logic, parallax errors are eliminated and timing accuracy is improved considerably over existing timing options. The Smart Timer's internal microcontroller also eliminates the problem of incorrect readings due to multiple passes through the same photogate by "understanding" the type of measurement selected and ignoring multiple passes.

The Smart Timer has many different options for timing and calculating values based on inputs from a variety of sensors. The graphics on the keypad aid in the selection of the appropriate timing mode. Options include One or Two Gates, Fence, and Pendulum modes. These modes allow you to measure the speed of an object as it passes through the photogate or between two photogates, or to measure the period of a pendulum. The stopwatch mode lets you use the timer as an electronic stopwatch.

The Smart Timer can measure speed and acceleration for both linear and rotational motion experiments. Alternatively, the time can be measured directly, and the speed and acceleration can then be calculated by the student. The speed and acceleration measurement features can be enabled or disabled using a switch inside the Smart Timer.

### ***Use With Photogates:***

The Smart Timer is optimized for use with PASCO's ME-9204B Accessory Photogate (available separately). These narrow-beam infrared photogates plug directly into the Smart Timer and are used to provide the timing signals. An LED in one arm of the photogate emits a narrow infrared beam. As long as the beam strikes the detector in the opposite arm of the photogate, the signal to the timer indicates that the beam is unblocked. When an object blocks the beam so it doesn't strike the detector, the signal to the timer changes.

---

In One Gate Mode, a single photogate lets you measure the time, velocity, or acceleration of a fence as it passes through the photogate. Two photogates are used for collision experiments using one or two carts or for experiments where the velocity of a cart must be measured at two different points. In Two Gate Mode, two photogates are used and the time to travel between the two can be measured. This mode can also be used to measure time of flight using the ME-6810 Time-of-Flight Accessory.

***Use with the Smart Pulley:***

For rotary motion studies, the ME-9387 Smart Pulley (available separately) is ideal. It combines a photogate with a pulley, and when used with the Smart Timer, allows direct measurement of angular speed and acceleration. When used with a string connected to a glide or Dynamics Cart, the Smart Timer and Smart Pulley can be used to determine linear acceleration ( $\text{cm/s}^2$ ) as well.

► **Note:** The use of pulleys with different diameters and/or different number of spokes than the Smart Pulley or the ME-9450 Super Pulley will give incorrect results in the speed and acceleration calculations.

***Power Options:***

The Photogate Timer can be powered using the included 9VDC adapter. It will also run on 4-AA size, 1.5 volt alkaline batteries which will provide over 100 hours of operation in typical use.

***Experiments:***

Four copy-ready experiments and 9 additional suggested experiments are included in this manual, showing a variety of ways to use the Smart Timer. The equipment requirements vary for different experiments. For many of the experiments, you will need a Dynamics Track and Dynamics Carts. Some experiments also require two ME-9204B Accessory Photogates or the ME-9387 Smart Pulley. Check the equipment requirements listed at the beginning of each experiment.

# Equipment

- Included:**  
**Smart Timer**  
**Smart Timer Picket Fences (2)**  
**9 VDC adapter**

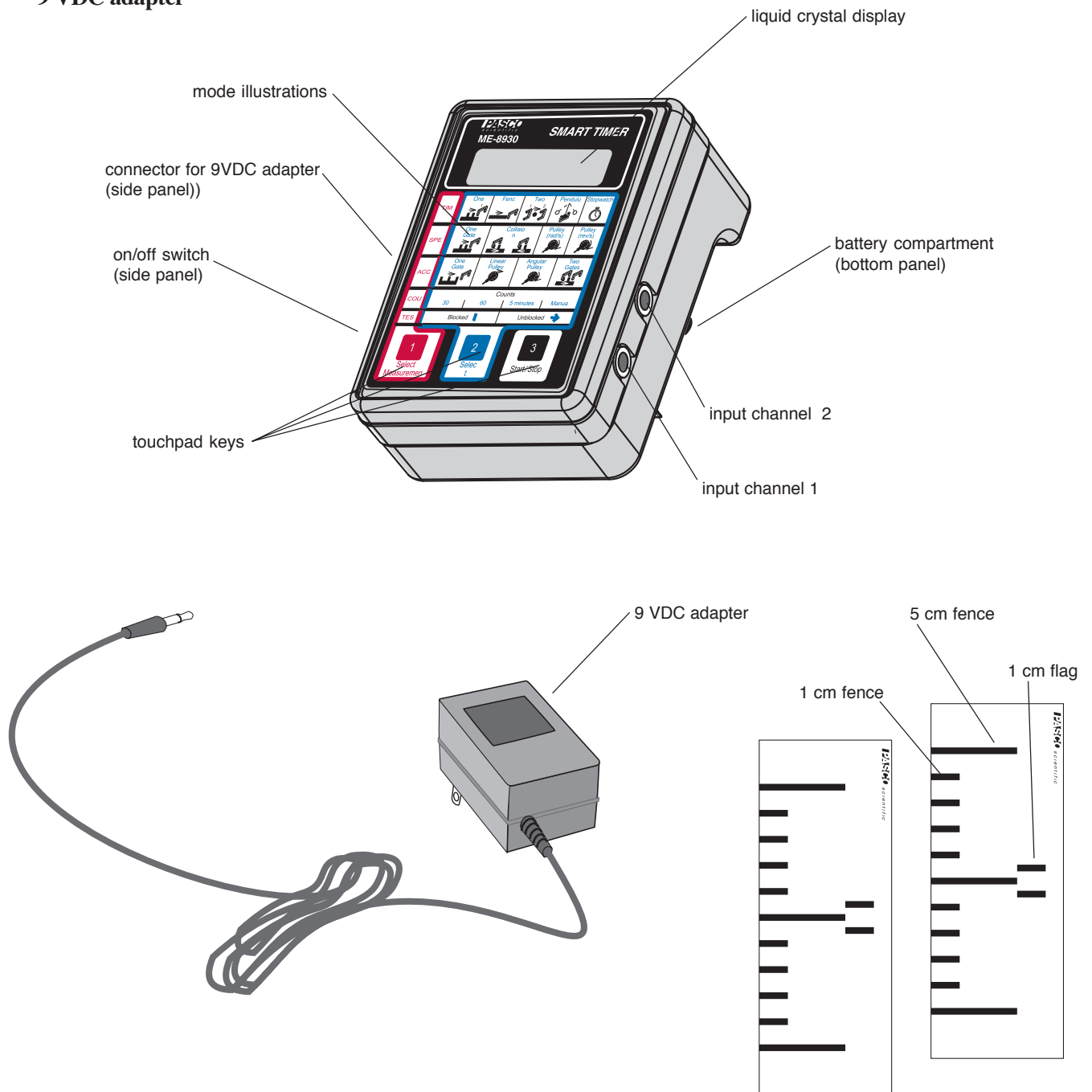

**Figure 1**  
 Included equipment

Smart Timer Picket Fences

## Operating the Smart Timer

1. Plug the ¼-inch phone plug from the photogate into the Smart Timer's input channel 1 or 2 (see Figure 2). For all experiments using a single photogate or pulley, either of the two available jacks may be used interchangeably. For all other modes see the individual descriptions below.
2. Plug the 9 VDC power adapter into the small receptacle on the side of the timer and into a standard 110 VAC, 60 Hz wall outlet.
3. Position the photogate head so the object to be timed will pass through the arms of the photogate, blocking the photogate beam. Loosen the clamp screw if you want to change the angle or height of the photogate, then tighten it securely.
4. Slide the power switch to the ON position. The Smart Timer will “beep” and show **PASCO scientific** on the display. From this point, the three-step setup of the Smart Timer is easy:
  1. Press the **Select Measurement** key until the desired measurement type is displayed on the top line of the display. Note that the menu rolls over to the beginning after the last type is selected.
  2. Press the **Select Mode** key until the measurement mode is displayed after the measurement type. You cannot begin a measurement until both the type and mode have been selected.
  3. Once a complete measurement has been selected, press **Start/Stop** to begin. You will hear a “beep”, and an asterisk (\*) will appear on the second line of the display. In most modes, the (\*) indicates that the Smart Timer is now waiting for an event to occur, like a fence passing through a photogate.
5. If an event occurs, the Smart Timer beeps again, displays a result, and the (\*) disappears. Pressing **Start/Stop** before an event occurs will remove the (\*) and allow you to change the measurement type.

### Smart Timer Modes of Operation

The Smart Timer has 18 modes of operation organized into five groups: **Time**, **Speed**, **Acceleration**, **Counts**, and **Test**. A

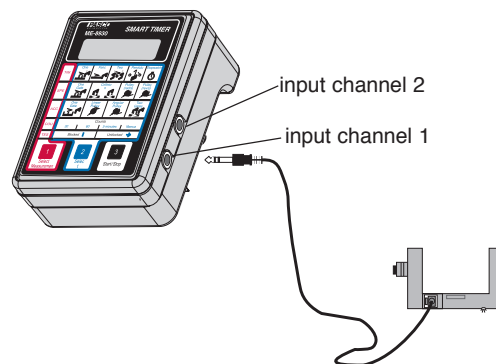

**Figure 2**  
Connecting the photogate to the Smart Timer





► **Note:** Smart Timers shipped to certain locations are supplied with a transformer for 220/240 VAC, 50 Hz power.



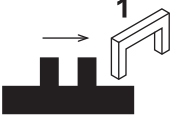

#### ► Important Setup Note:

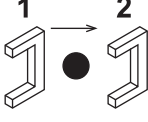
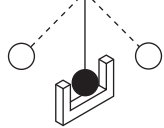

The Smart Timer incorporates a feature to increase the battery lifetime. The photogate turns on only when **Start/Stop** is pressed to start an experiment. Photogate power is turned off when the measurement is complete or the operator presses **Start/Stop**. The exception is the **Test** mode in which photogate power is turned on as soon as the display reads **Test:Gates** and is not turned off until **Select Measurement** is pressed again. Setup for the experiment is often best accomplished in **Test:Gates** mode.

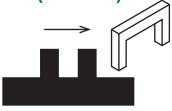

## Quick Cross-Reference for Suggested Activities and Smart Timer Modes

<b>TIME</b>	<p><b>One Gate</b></p> 	<p><b>Fence</b></p> 	<p><b>Two Gates</b></p> 	<p><b>Pendulum</b></p> 	<p><b>Stopwatch</b></p> 
	<ul style="list-style-type: none"> <li>Use the time measurement to calculate the speed of a cart.</li> </ul>	<ul style="list-style-type: none"> <li>Use time measurements to determine the acceleration of a cart or the acceleration due to gravity of a Picket Fence.</li> </ul>	<ul style="list-style-type: none"> <li>Use the time measurement to calculate the launch speed of a ball.</li> <li>Operate the Time-of-Flight Accessory</li> </ul>	<ul style="list-style-type: none"> <li>Measure the period of a pendulum.</li> </ul>	<ul style="list-style-type: none"> <li>Time students running.</li> <li>Operate Free Fall Adapter and Laser Switch.</li> </ul>

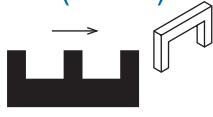
<b>SPEED</b>	<p><b>One Gate (cm/s)</b></p> 	<p><b>Collision (cm/s)</b></p> 	<p><b>Pulley (rad/s)</b></p> 	<p><b>Pulley (rev/s)</b></p> 
	<p>Measure the speed of a cart.</p>	<p>Measure the initial and final speeds of two carts during a collision for conservation of momentum.</p>	<p>Measure one speed on a Smart Pulley.</p>	<ul style="list-style-type: none"> <li>Continuously monitor angular speed in conservation of angular momentum experiments.</li> </ul>

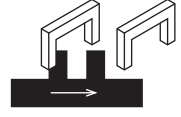
<b>ACCEL</b>	<p><b>One Gate (cm/s<sup>2</sup>)</b></p> 	<p><b>Linear Pulley (cm/s<sup>2</sup>)</b></p> 	<p><b>Angular Pulley (rad/s<sup>2</sup>)</b></p> 	<p><b>Two Gates (cm/s<sup>2</sup>)</b></p> 
	<ul style="list-style-type: none"> <li>Measure acceleration of a cart at one point on the track.</li> <li>Measure the acceleration due to gravity (g) of a Picket Fence.</li> </ul>	<p>Measure the acceleration of a hanging mass in rotational inertia experiments.</p>	<p>Measure the acceleration of a hanging mass in rotational inertia experiments.</p>	<p>Measure the average acceleration of a cart over the whole length of the track.</p>

<b>COUNTS</b>	30 seconds	Counts for 60 seconds	5 minutes	Manual
	<ul style="list-style-type: none"> <li>Count blocking events for the specified period of time.</li> <li>Measure radiation emission events with the GM Tube/Power Supply.</li> </ul>			

summary of the mode suggested for a given experimental activity can be found on page 5 (Quick Cross-Reference for Suggested Activities and Smart Timer Modes). Refer to the timing diagrams in Table 1 (pages 8 and 9) for a detailed look at how the Smart Timers times events on its input(s) and an explanation of how speed and acceleration calculations are performed internally.

The following are detailed descriptions of the Smart Timer's modes of operation.

## Time Modes

**One Gate:** In One Gate mode, timing begins when the beam is first blocked and continues until the beam is blocked again. This mode can be used to measure the speed of an object as it passes through the photogate. If an object of length  $L$  blocks the photogate for a time  $t$ , the average velocity of the object as it passed through the photogate was  $L/t$ .

**Fence:** In Fence mode, the timer measures the time between successive interruptions of the photogate. Timing begins when the beam is first blocked and continues until the beam is unblocked and then blocked again. The Smart Timer can remember ten such interruptions and will allow the user to scroll through the times using either the **Select Measurement** or the **Select Mode** keys. Pressing the **Start/Stop** once will allow another measurement type to be selected. Pressing it twice begins a new Fence Mode measurement. Note that once a measurement has begun with an initial block of the photogate, the Smart Timer will continue to time until ten interruptions are counted before stopping the measurement and displaying the result. Pressing **Start/Stop** will stop the measurement, and any recorded times will be displayed.

**Two Gates:** In this mode, the Smart Timer measures the time between blocking two photogates. This mode is useful for not only air tracks and Dynamics Tracks but also with the ME-6810 Time-of-Flight Accessory. In this mode, you must plug the photogate you expect to encounter first into input channel 1, and the second photogate into input channel 2.

**Pendulum:** In Pendulum mode, the timer measures the period of one complete oscillation. Timing begins as the pendulum first cuts through the beam. The timer ignores the next interruption, which corresponds to the pendulum swinging back in the opposite direction. Timing stops at the beginning of the third interruption, as the pendulum completes one full oscillation. Press the **Start/Stop** key again to begin a new timing cycle.

**Stopwatch:** The Manual mode is actually a dual-use function. It provides a means of manually timing events (like a using a Stopwatch) by pressing the **Start/Stop** key. It also allows timing of events using the ME-9207B Free-Fall Adapter and the ME-9259A Laser Switch, which function via a block/unblock sequence.

*Using the Stopwatch:* Enter **Stopwatch** mode and press the **Start/Stop** key. The Smart Timer will beep and a "\*" will appear on the second line of the LCD. Press the **Start/Stop** key again to start the timer. Press the **Start/Stop** key to stop timing and display the elapsed time. Press the **Start/Stop** key again. The old result is

► **Note:** The picket fence supplied with the Smart Timer is designed to increase timing accuracy when used with photogates. The fence has three sections: the 1 cm flag, the 5 cm fence, and the 1 cm fence; one of these must be aligned with the photogate light path before the experiment can proceed.

cleared and the “\*” reappears. This RESET-START-STOP sequence is repeated for each new elapsed time. Whenever the “\*” is not showing, the mode may be changed.

**Using the Alternate Timing Function:** Connect an appropriate accessory to input channel #1 or #2. Enter **Stopwatch** mode and press the **Start/Stop** key. The Smart Timer will beep and a “\*” will appear on the second line of the LCD. At this time the accessory will be powered. By blocking and unblocking the beam in the case of the Laser Switch, or by dropping the steel ball in the case of the Free Fall Adapter, the elapsed time will be measured. The Smart Timer will resolve 100 microseconds in the alternate timing mode.

► **Notes about the Stopwatch Mode:**

1. Although it is possible to use older style fences in the alternate timing function to obtain photogate beam block times, the Smart Timer will provide much higher accuracy when used with the included fences and the standard timing modes.
2. Two photogates cannot be plugged into the Smart Timer when you are using a photogate to start and stop the timer. A single photogate can be plugged into channel #1 or #2 to start and stop the timer. But if two photogates are plugged in, when one gate is blocked, the other gate immediately is counted as an unblock, and the timer will display 0.0001 seconds, regardless of the length of time the first photogate is blocked.
3. You cannot start the timing with the **Start/Stop** key and end it with a photogate block or vice versa.
4. If a photogate is plugged in and blocked when you try to use the **Start/Stop** key as a stopwatch, the Smart Timer will be timing the photogate and waiting for the photogate to become unblocked. So when you push the **Start/Stop** key, the asterisk disappears and when you push the **Start/Stop** key again, the asterisk reappears. No time is displayed until the photogate is unblocked.

## Speed Modes

**One Gate:** In this mode a 1 cm flag passes through the photogate. The Smart Timer measures the time and calculates the average speed in cm/s.

**Collision:** In this mode either one or two carts and one or two photogates can be used for a collision experiment. Once **Start/Stop** is pressed, the Smart Timer waits for the first collision and begins timing. The Smart Timer stops timing when two carts have passed through their respective photogates twice. Timing can always be stopped manually by pressing **Start/Stop** and the Smart Timer will display speed(s) based on the information it has (you will need to press **Start/Stop** for single cart collisions). The display will present the results in the following format:

- 1: xx.x,yy.y
- 2: xx.x,yy.y

The first number represents the input jack and the following two numbers indicate the initial speed (xx.x) and final speed (yy.y), respectively.













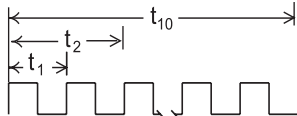

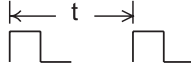
► **Note:**

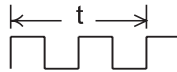
The stopwatch function is not a precision timing mode and is therefore most useful for events that are longer than one second. The accuracy of the stopwatch is +/-10 milliseconds.

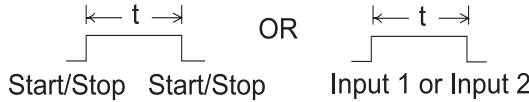
► **Hint:**

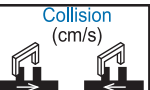
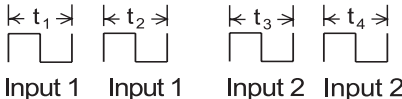
For easier alignment of the laser with the Laser Switch, use the **Test:Gates** mode.

# Table 1. Summary of Smart Timer Modes

Type	Modes	Key Sequence*	Timing Diagram**	Calculation Algorithm
Time	 One Gate	1 2	 Input 1 or Input 2	
	 Fence	1 2 2	 Input 1 or Input 2	
	 Two Gates	1 2 2 2	 Input 1    Input 2	
	 Pendulum	1 2 2 2 2	 Input 1 or Input 2	
	 Stop Watch	1 2 2 2 2 2	 Start/Stop    Start/Stop    Input 1 or Input 2 <b>Manual timing of events</b> <b>Automatic timing of events</b>	
Speed	 One Gate (cm/s)	1 1 2	 Input 1 or Input 2	Speed = 1cm / t
	 Collision (cm/s)	1 1 2 2	 Input 1    Input 1    Input 2    Input 2	Speed <sub>n</sub> = 1cm / t <sub>n</sub>
	 Pulley (rad/s)	1 1 2 2 2	 Input 1 or Input 2	Speed = ((2 * pi rad/rev) * 0.1rev) / t
	 Pulley (rev/s)	1 1 2 2 2 2	 Input 1 or Input 2	Speed = 0.1rev / t

**Acceleration**



One Gate

1 1 1 2

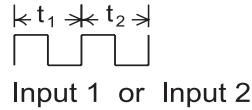

$$\text{Accel} = 2 * (5\text{cm}/t_1 - 5\text{cm}/t_2) / (t_1 + t_2)$$



Linear Pulley

1 1 1 2 2

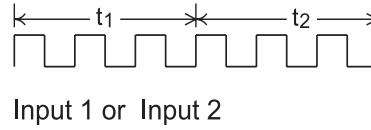

$$\text{Accel} = 2 * ((0.4\text{rev} * 15\text{cm})/t_1 - (0.4\text{rev} * 15\text{cm})/t_2) / (t_1 - t_2)$$



Angular Pulley

1 1 1 2 2 2

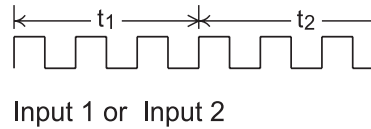

$$\text{Accel} = 2 * [0.4\text{rev} * 2 * \pi * ((1/t_1) - (1/t_2)) / (t_1 - t_2)]$$



Two Gates

1 1 1 2 2 2 2

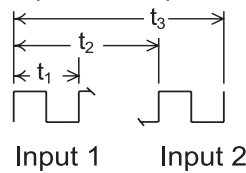

$$dT_1 = t_1, dT_2 = t_3 - t_2$$

$$dT = t_2 + ((t_3 - t_2)/2 - t_1/2) = (t_2 + t_3 - t_1) / 2$$

$$v_1 = 1\text{cm}/dT_1, v_2 = 1\text{cm}/dT_2, dV = v_2 - v_1$$

$$a = dV / dT$$

**Counts**

30 seconds

1 1 1 1 2

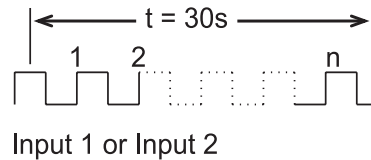

Count = n

60 seconds

1 1 1 1 2 2

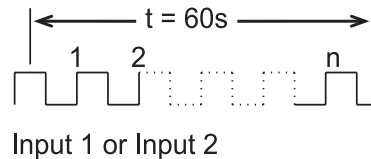

Count = n

5 minutes

1 1 1 1 2 2 2

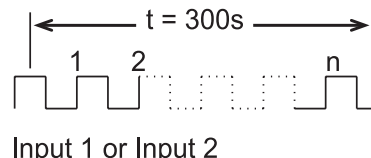

Count = n

Manual

1 1 1 1 2 2 2 2



**Test**

One Gate

1 1 1 1 1 2

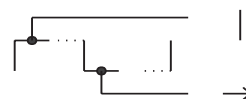

\* The key sequences shown are valid in the initial or power-on situation only.

**\*\*Key** Photogate Blocked Photogate Unblocked

**Note:** The length of the line is not related to the length of the time interval.

**Pulley (rad/s):** The Smart Timer will measure the speed of a pulley passing through a photogate in units of radians/second. One measurement will be taken each time the **Start/Stop** switch is pressed. The Smart Timer cannot differentiate between clockwise and counterclockwise directions. Note that, as in many other modes, if a “\*” shows in the first character position of the second line, the Smart Timer is actively waiting for an external timing event to occur. If the “\*” is not showing, the Timer measurement mode may be changed. This mode has a minimum speed requirement. The photogate must be blocked twice within two seconds to obtain a valid reading, translating to a minimum speed of 0.31 rad/s.

**Pulley (rev/s):** Besides displaying in different units, this mode uses the display differently than in the radians/second measurement. The display provides a real-time measurement of the speed of the pulley by updating once per second. Once a speed is displayed, press the **Start/Stop** key to freeze the display. The Smart Timer indicates that the measurement is frozen by displaying a “!” in the first column. Press **Start/Stop** to erase the “!” and start collecting new measurements. Any time the first column is blank or has a “!” displayed, the type of measurement being done can be changed by pressing the **Select Measurement** or **Select Mode** keys. To move to a different measurement, press **Start/Stop** again. Like the radians/second measurement, there is a two-second maximum time for two photogate blocks, translating to a minimum speed of 0.05 rev/s. Also note that accuracy decreases rapidly as pulley speeds increase above 600 rpm. At 600 rpm, accuracy is 1%.

## Acceleration Modes

**One Gate:** The Smart Timer uses the time measurement between two equally spaced (5 cm) block/unblock/block sequences to calculate average acceleration. In activities using the Smart Timer Picket Fence, the Picket Fence must be positioned so that the photogate blocks only the 3-bar segment (5cm fence) of the Picket Fence. Note that the Smart Timer is able to discern between acceleration (positive number) and deceleration (negative number).

**Linear Pulley:** In this mode, the Smart Timer converts rotary motion of a PASCO pulley to an equivalent linear acceleration in  $\text{cm/s}^2$ .

**Angular Pulley:** In this mode, the Smart Timer converts rotary motion of a PASCO pulley to an equivalent angular acceleration in  $\text{rad/s}^2$ .

**Two Gates:** When two photogates are placed an arbitrary distance apart, the average acceleration between the two can be calculated. In this mode, the inputs used are not arbitrary. The first photogate to be encountered must be connected to input #1 and the second to input #2.

## Count Modes:

**30 Seconds:** The timed 30-second count mode will count high-to-low voltage transitions on either input and display them on the second line of the liquid crystal display. After the counting period is over, the Smart Timer will beep once, remove the power to the external device, and freeze the display. Pressing **Start/Stop** erases the old count and begins a new

timing interval. If you wish to stop the count during a timing interval, press **Start/Stop**. The display will freeze the current count and the “\*” will disappear from the first column. At this time you may select a new measurement or start a new timing interval. The maximum counting rate for any of the counting modes is 5,000 counts per second and the maximum count is 9,999,999.

**60 Seconds:** Other than timing the count interval for 60 seconds, the 60-second count mode is the same as the 30-second mode.

**5 Minutes:** Other than timing the count interval for 5 minutes, the 5-minute count mode is the same as the 30-second mode

**Manual:** Manual mode will count high-to-low voltage transitions on either input and display them on the second line of the liquid crystal display. There is no time limit for counting, however the upper limit on the number of total counts is still 9,999,999. Each count will be accompanied by a short beep. Used with a PASCO SN-7927 G-M Tube/Power Supply, this mode is useful for group demonstrations to show the random nature of atomic disintegration and the inverse-square relationship between number of disintegration’s detected and distance from the radioactive source.

## Test Mode

**Gates:** In the Test:Gates measurement, the external measuring accessory is powered as long as the top line of the display reads **Test:Gates**. This mode is useful for experiment setup or for testing accessory photogates, G-M tubes, or other Smart Timer accessories. Pressing the **Select Measurement** key will exit the test mode and remove power to the external device. The display graphics depict a blocked photogate as a vertical line and an unblocked photogate as an arrow.

## Timing Diagrams

The timing diagrams on pages 8 and 9 show the interval,  $t$ , that is measured in each timing mode. In each diagram, an elevated line corresponds to the photogate being blocked, and a depressed line corresponds to the photogate being unblocked. The calculation modes assume the use of a fence of fixed width (1 cm or 5 cm) or a pulley having a diameter (groove to groove) of 4.8 cm and 10 spokes, such as the Super Pulley or Smart Pulley.

## LOCK Switch

The internal LOCK switch provides a way to temporarily lock out speed and acceleration modes. To access the LOCK switch, turn the power off, and remove the bottom half of the Smart Timer case as if you were going to replace the batteries. Look along the lower edge of the printed circuit board, and note the LOCK switch button at the edge (Figure 3). The circuit board also has the words “LOCK” and “UNLOCK” printed along the same edge. Moving the switch to the LOCK position will cause the display to read **MODE UNAVAILABLE** whenever speed or acceleration modes are selected.

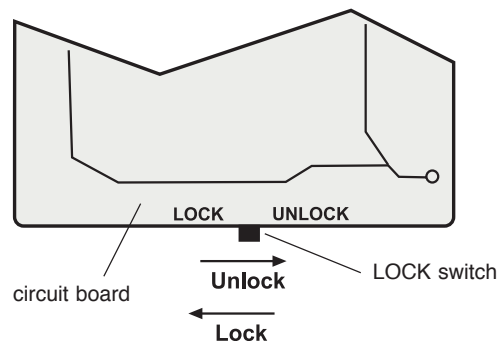

**Figure 3**

Location of the LOCK switch on the circuit board.



---

## *Caring for the Smart Timer*

- Do not use a pointed object (such as a pen) to press the keypad buttons. Wrap the Smart Timer separately when transporting it with other items. The transparent covering over the keypad can be creased by a fingernail or other sharp object.
- Clean the keypad with a soft cloth and mild detergent, avoiding hard rubbing of the transparent window.
- Do not leave the Smart Timer exposed to direct sunlight except for brief periods. Strong ultraviolet light can damage the Smart Timer display.
- Remove the batteries prior to storage for more than one month. Batteries can leak and damage the internal circuitry, especially if the batteries are old.
- For best results, use alkaline batteries. Rechargeable NiCad batteries may be used, but the operating time between charges is much shorter than the lifetime of alkaline batteries.

## *Specifications*

**Resolution:** The basic timing resolution of the Smart Timer is 100 microseconds in all modes except Stopwatch, which is 10 ms.

**Calculated Values:** Calculated values are displayed to one or two decimal places with typical accuracy being  $\pm 1$  in the least significant digit. For extremely high speeds (such as might be generated by hand spinning a Super Pulley), accuracy is degraded for calculated parameters because of the very short timing intervals involved.

**Maximum Output Power:** The Smart Timer allows many different accessories to be used as inputs. The total 5-volt load (both inputs added together) that can be accommodated is 180 mA, maximum.

## *Accessory Options*

The following PASCO accessories are available to help extend the utility of the Smart Timer. See the current PASCO catalog for more information.

**Accessory Photogate (ME-9204B):** The stereo phone plug of the Accessory Photogate plugs into either of the phone jacks on the side of the Smart Timer, giving you the option of two identical photogates operating from a single timer. (Some of the experiments in this manual require the use of a Smart Timer with two Accessory Photogates.)



---

**Time-of-Flight Accessory (ME-6810):** The Timer-of-Flight Accessory facilitates the accurate measurement of the flight time of a ball launched by a PASCO projectile launcher. See page 33 (*Time of Flight and Initial Velocity* and Figure 9.1) for details of the setup.

**Free Fall Adapter (ME-9207B):** The Free Fall Adapter facilitates easy and accurate measurements of the acceleration of gravity. It comes with everything you need, including two steel balls (of different size and mass), a release mechanism, and a receptor pad. The release mechanism and the receptor pad automatically trigger the Smart Timer, so you get more accurate measurements of the free fall time of the steel ball. See page 34 (*Determining the acceleration due to gravity (g) with the Free Fall Adapter* and Figure 10.1) for details of the setup.

**Laser Switch (ME-9259A):** This highly collimated photodetector is identical to a photogate, except that a laser (available separately) is used as the light source. With the Laser Switch, the motion of objects that are too big to fit through a standard photogate can be measured. Thus, you can measure the period of a bowling ball pendulum or the velocity of a car, for example.

**G-M Tube/Power Supply (SN-7927):** The G-M Tube Power Supply is a Geiger-Muller Probe that senses beta, gamma, and alpha radiation. See page 34 (*Counting radiation with the G-M Tube/Power Supply* and Figure 11.1) for details of the setup.



# Experiment One: Acceleration Due to Gravity

## EQUIPMENT AND MATERIALS REQUIRED

- Smart Timer (ME-8930)
- Smart Timer Picket Fence
- Photogate (ME-9498A)

## Purpose

The purpose is to determine the acceleration due to the Earth's gravity.

## Theory

The accepted value for the acceleration due to gravity on the Earth's surface is  $9.8 \text{ m/s}^2$ . With the Smart Timer, the acceleration due to Earth's gravity can be quickly determined experimentally. The acceleration may be calculated from measurements of distance and time, or it can be measured directly.

To calculate the acceleration from time measurements, the following formula must be used:

$$g = \frac{\Delta v}{\Delta t} = \frac{v_2 - v_1}{\frac{1}{2} t_2}$$

where

$$v_1 = \frac{5\text{cm}}{t_1} \quad \text{and} \quad v_2 = \frac{5\text{cm}}{t_2 - t_1}$$

Note that  $\Delta t$  is not  $t_2$ , but is  $\frac{1}{2} t_2$  (see Figure 1.1).

$$\begin{aligned} \Delta t &= \frac{1}{2} t_1 + \frac{1}{2} (t_2 - t_1) \\ &= \frac{1}{2} t_1 + \frac{1}{2} t_2 - \frac{1}{2} t_1 \\ \Delta t &= \frac{1}{2} t_2 \end{aligned}$$

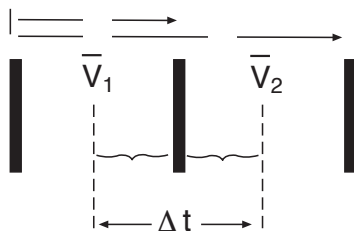

**Figure 1.1**

Explanation of why  $\frac{1}{2} t_2$  is used in the formula for calculating  $g$

## Procedure

### PART A—Determining the acceleration from time and distance measurements

1. Mount the photogate on a stand, or hold the Photogate steady so it is parallel to the floor, as shown in Figure 1.2.

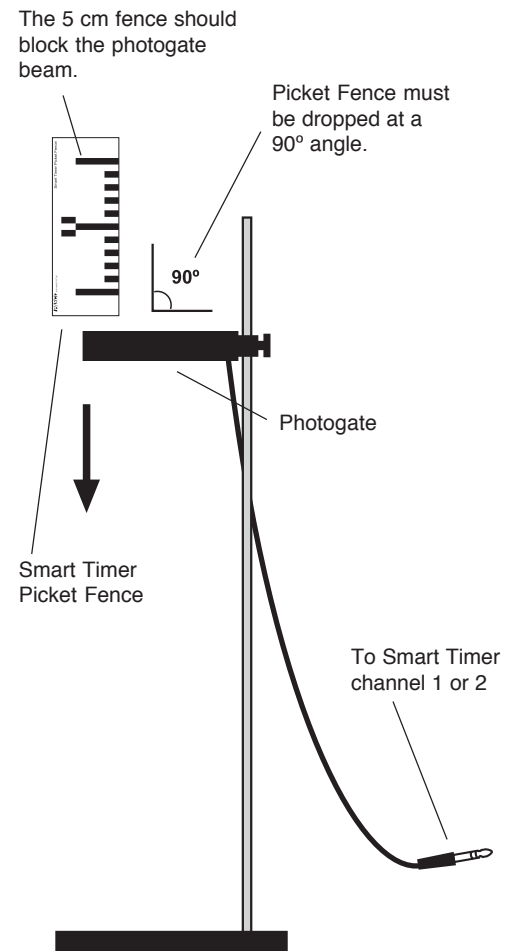

**Figure 1.2**  
Experiment setup

2. Insert the plug of the photogate into channel 1 or 2 of the Smart Timer, and set up the Smart Timer to measure **Time, Fence**.
3. Hold the Smart Timer Picket Fence in a position so it will drop vertically through the photogate and so the 5 cm fence will block the photogate beam as the fence drops through the photogate.

**Note:** Three conditions must be met for greatest accuracy:

1. The Picket Fence must be dropped at a  $90^\circ$  angle to the photogate beam in such a way that it does not rotate on the way down. One method to improve the drop is to hold the edge of the Picket Fence with a clothespin or binder clip, and drop the fence by squeezing the clothespin or clip.
  2. The Picket Fence must be dropped so the 5 cm marks cut the photogate beam.
  3. The Picket Fence must pass close to the LED that emits the photogate beam.
4. Press **3** and drop the fence.
  5. Record  $t_1$  and  $t_2$ , and calculate the acceleration in meters/second<sup>2</sup>.

#### **PART B—Determining the acceleration directly.**

1. Repeat steps 1 – 4 in Part A with the following modification: Set the Smart Timer to measure **Acceleration: One Gate**. Repeat several times and calculate the average acceleration ( $g$ ).

### **Questions**

1. How do the two methods for determining the acceleration on a body due to Earth's gravity compare?
2. How do the experimental measurements compare to accepted values?

## Experiment Two: Newton's Second Law

### EQUIPMENT AND MATERIALS REQUIRED

- Smart Timer (ME-8930)
- Dynamics Cart (ME-9430 or ME-9454)
- Dynamics Cart Track (ME-9429A)
- 500 gram bar mass
- Super Pulley (ME-9450)
- Photogate (ME-9498A)
- Photogate Bracket (part no. 003-04662)
- Mass Hanger and Mass Set (ME-9348)
- Ohaus Triple-Beam Balance (SE-8707) or similar
- Physics String (SE-8050)

### Purpose

The purpose is to verify Newton's Second Law,  $\mathbf{F} = \mathbf{ma}$ .

### Theory

Newton's Second Law,  $\mathbf{F} = \mathbf{ma}$ , is a description of the relationship between  $\mathbf{F}$ , the net force acting on the object of mass  $\mathbf{m}$ , and  $\mathbf{a}$ , the resulting acceleration of the object. For a cart of mass  $\mathbf{m}_1$  on a horizontal track with a string attached over a pulley to a mass  $\mathbf{m}_2$  (see Figure 2.1), the net force  $\mathbf{F}$  on the entire system (cart and hanging mass) is the weight of hanging mass,  $\mathbf{F} = \mathbf{m}_2\mathbf{g}$ , assuming that friction is negligible.

According to Newton's Second Law, this net force should be equal to  $\mathbf{ma}$ , where  $\mathbf{m}$  is the total mass that is being accelerated, which in this case is  $\mathbf{m}_1 + \mathbf{m}_2$ . This experiment will check to see if  $\mathbf{m}_2\mathbf{g}$  is equal to  $(\mathbf{m}_1 + \mathbf{m}_2)\mathbf{a}$ .

### Procedure

1. Level the track by setting the cart on the track to see which way it rolls. Adjust the leveling screw at the end of the track to raise or lower that end until the cart placed at rest on the track will not move toward either end.
2. Use the balance to find the mass of the Dynamics Cart and record the mass in Table 2.1.
3. Attach the Super Pulley to the end of the track as shown in Figure 2.1.
4. Connect the Photogate to the Smart Timer, and adjust the Photogate so that when the pulley turns, the spokes of the pulley will block the photogate beam.

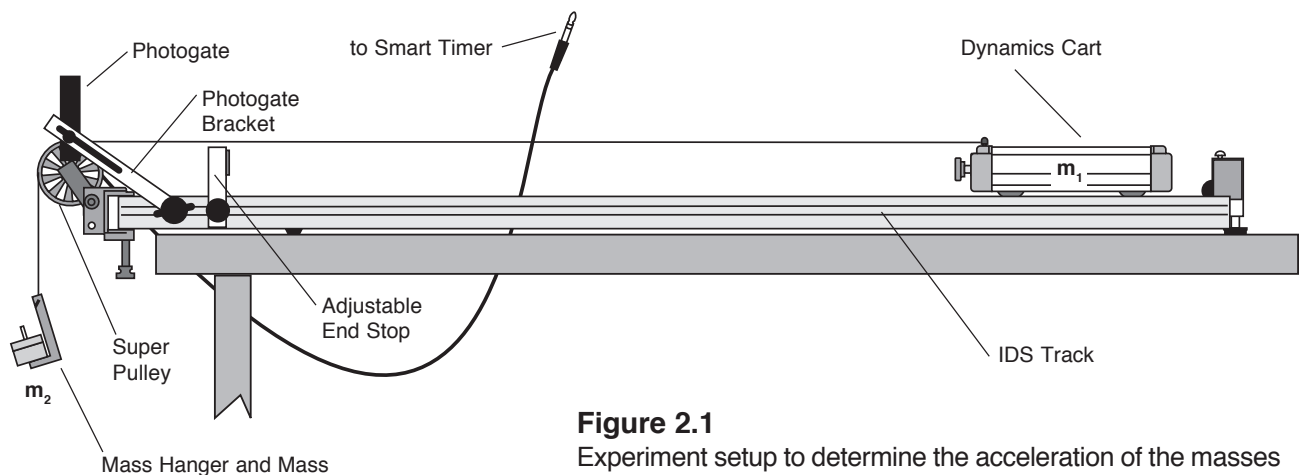

**Figure 2.1**

Experiment setup to determine the acceleration of the masses

- Place the Dynamics Cart on the track, attach a string to the hole in the end of the cart, and tie a mass hanger on the other end of the string. The string must be just long enough so the cart hits the end stop before the mass hanger reaches the floor.
- Pull the cart back until the mass hanger reaches the pulley. Make a test run to determine how much mass is required on the mass hanger so that the cart takes about 2 seconds to complete the run. Record the hanging mass in Table 2.1.
- Set up the Smart Timer to record **Acceleration: Linear Pulley**.

*Note: Use masses of between 50 and 100 g, and be sure that the runs are not longer than 2 seconds.*

- Pull the cart back until the mass hanger reaches the pulley. Release the cart from rest, and activate the Smart Timer once the car has started moving. (The timing will begin when the photogate beam is first blocked.) Repeat this measurement 3 times with the same masses. Record all the values in Table 2.1. Calculate the average accelerations and record in Table 2.1.
- Increase the mass of the cart using the bar mass and repeat the procedure.

**Table 2.1 Data**

cart mass ( $m_1$ )	hanging mass ( $m_2$ )	accel. 1	accel. 2	accel. 3	ave. accel. $a$	measured force $(m_1 + m_2)a$	theoretical force $m_2g$	% difference*

$$* \% \text{ difference} = \left| \frac{\text{theoretical} - \text{measured}}{\text{theoretical}} \right| \times 100\%$$

### Analysis

- Calculate the measured force  $F = (m_1 + m_2)a$  and record in Table 2.1.
- Calculate the theoretical force  $F = m_2g$  and record on Table 2.1.
- Calculate the percent difference of the theoretical force vs. the measured force and record in Table 2.1.

### Questions

- Did the results of this experiment verify that  $F = ma$ ? Explain.
- Why is the mass in  $F = ma$  not just equal to the mass of the cart?
- When calculating the force on the cart using mass times gravity, why isn't the mass of cart included?
- Discuss the impact on the results of assuming the frictional force to be zero.

## Experiment Three: Conservation of Momentum In Collisions

### EQUIPMENT AND MATERIALS REQUIRED

- Smart Timer (ME-8930)
- Collision Cart with mass (2) (ME-9454)
- Dynamics Cart Track (ME-9429A)
- (2) Photogate (ME-9498A)
- (2) Photogate Bracket (Part No. 003-04662)
- (2) Smart Timer Picket Fence
- balance

### Purpose

The purpose of this experiment is to show that momentum is conserved in collisions.

### Theory

When two carts collide with each other, the total momentum ( $p = mv$ ) of both carts is conserved regardless of the type of collision. An elastic collision is one in which the two carts bounce off of each other with no loss of kinetic energy — accomplished in this experiment, through the use of the carts' magnetic bumpers. A completely inelastic collision is one in which the two carts hit and stick to each other — accomplished in this experiment using the Velcro patches on one end of each cart.

### Procedure

#### PART A: Inelastic Collisions

1. Level the track by setting a cart on the track to see which way it rolls. Adjust the leveling screw at the end of the track to raise or lower that end until a cart placed at rest on the track will not move.
2. Put a Picket Fence into the slots in the top of each cart and place the Collision Carts so the Velcro patches face each other. Position the two photogates just far enough apart so the collision can take place between the photogates. Adjust the height of the photogate so the 1 cm fence will block the photogate beams. Connect the photogates to the Smart Timer (see Figure 3.1).

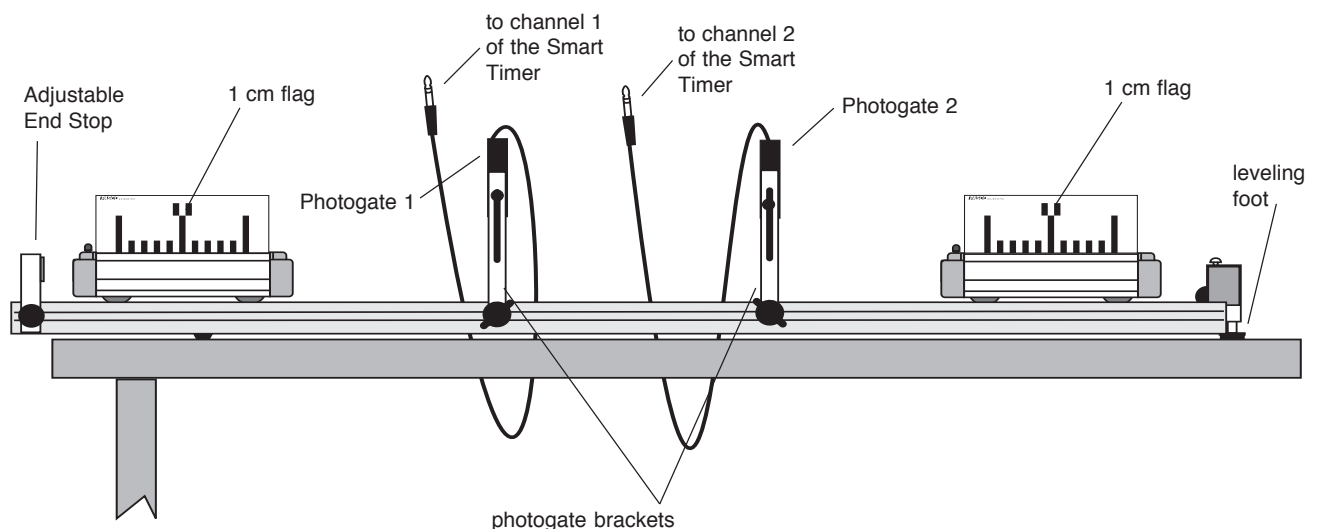

**Figure 3.1**  
Experiment setup for *Conservation of Momentum* experiments

3. Set up the Smart Timer to measure **Speed: collision (cm/s)**. Press **3** to activate the Smart Timer.

► **Note:** If the flags of both carts do not go through the photogate beams twice, the Smart Timer will not complete the timing cycle and display velocities automatically. You will need to push **3** to stop timing. The completed timing measurements will be displayed, and the uncompleted measurements will be registered as 0. Press **1** or **2** to view the velocities from photogate 2. You can scroll back and forth between the displayed velocities from photogates 1 and 2 by pressing either of these keys. Press **3** to reactivate the **Speed: collision (cm/s)** mode or to change modes.

4. Perform each of the following completely inelastic collisions:

#### Equal Masses

- Place one cart at rest in the middle of the track. Give the other cart an initial velocity toward the cart at rest.
- Start both carts at one end of the track. Give the first cart a slow velocity and the second cart a faster velocity so that the second cart catches the first cart.

#### Unequal Masses

Put two mass bars in one of the carts so that the mass of one cart ( $3M$ ) is approximately three times the mass of the other cart ( $1M$ ). (Weigh the carts and record the masses in Table 3.1.)

- Place the  $1M$  cart at rest in the middle of the track. Give the  $3M$  cart an initial velocity toward the cart at rest.
- Start the carts at opposite ends of the track at approximately the same speed toward each other.
- Place both carts at one end with the  $1M$  in front of  $3M$ . Give  $3M$  a slightly greater velocity than  $1M$  so the carts collide between the photogates.

**Table 3.1 Data**

	$M_1$	$M_2$	$v_{\text{cart 1 before}}$	$v_{\text{cart 2 before}}$	$v_{\text{final}}$
Trial 1					
Trial 2					
Trial 3					
Trial 4					
Trial 5					

**Note:** Do each experiment at least 3 times.



## Analysis

1. For each of the cases, calculate the momentum of each cart before the collision. Record the results in Table 3.2.
2. For each of the cases, calculate the total momentum of both carts before the collision. Record the results in Table 3.2.
3. For each of the cases, calculate the total momentum of both carts after the collision. Record the results in Table 3.2.
4. For each of the cases, calculate the percent difference between the total momentum of the carts before and after the collision and record in the table.

## Questions

**Table 3.2 Results**

	$p_1$ Before	$p_2$ Before	$P_{\text{TOTAL}}$ Before	$P_{\text{TOTAL}}$ After	% of Difference
Trial 1					
Trial 2					
Trial 3					
Trial 4					
Trial 5					

1. When two carts moving toward each other have the same mass and the same speed, they stop when they collide and stick together. What happens to each cart's momentum? Is momentum conserved? Explain.
2. Kinetic energy is not conserved in inelastic collisions. For one of the collisions, calculate the percentage of the kinetic energy that is lost in the collision. Where does this energy go?

**Part B—Elastic Collisions**

Set up the carts so the magnetic ends face each other, so the carts will repel each other when they collide. Record the data in Tables 3.3 and 3.4.

**Equal Masses**

- a. Place one cart at rest in the middle of the track. Give the other cart an initial velocity toward the cart at rest.
- b. Start both carts at opposite ends of the track at approximately the same speed.

**Unequal Masses**

Put two mass bars in one of the carts so that the mass of one cart (3M) is approximately three times the mass of the other cart (1M). (Weigh the carts and record the masses in Table 3.3.)

- a. Place the 3M cart at rest in the middle of the track. Give the 1M cart an initial velocity toward the cart at rest.
- b. Start the carts at opposite ends of the track at approximately the same speed toward each other.
- c. Start cars at the same end, with the 3M car ahead of and moving slower than the 1M car.

*Note:* Do each experiment at least 3 times.

**Table 3.3 Data**

	$M_1$	$M_2$	$v_1$	$v_2$	FINAL $v_1$	FINAL $v_2$
Trial 1						
Trial 2						
Trial 3						
Trial 4						
Trial 5						
Trial 6						
Trial 7						

**Table 3.4 Results**

	$p_1$ Before	$p_2$ Before	$p_1$ After	$p_2$ After	$P_{\text{TOTAL}}$ Before	$P_{\text{TOTAL}}$ After	% of Difference
Trial 1							
Trial 2							
Trial 3							
Trial 4							
Trial 5							
Trial 6							
Trial 7							

**Questions**

1. Kinetic energy is not conserved in inelastic collisions but it is conserved in ideal elastic collisions. For one of the collisions, calculate the percentage of the kinetic energy that is lost in the collision. Was kinetic energy conserved? Explain your results.



## Experiment Four: Rotational Inertia of a Disk and Ring

### EQUIPMENT REQUIRED

- Rotating Platform (ME-8951)
- Rotational Inertia Accessory (ME-8953)
- Smart Pulley (ME-9387)
- Smart Timer (ME-8930)
- Ohaus Triple-Beam Balance (DE-8707) or similar
- paper clips (for masses < 1 g)
- calipers

### Purpose

The purpose of this experiment is to find the rotational inertia of a ring and a disk experimentally and to verify that these values correspond to the calculated theoretical values.

### Theory

Theoretically, the rotational inertia,  $I$ , of a ring about its center of mass is given by:

$$I = \frac{1}{2} M(R_1^2 + R_2^2)$$

where  $M$  is the mass of the ring,  $R_1$  is the inner radius of the ring, and  $R_2$  is the outer radius of the ring. See Figure 4.1a.

The rotational inertia of a disk about its center of mass (Figure 4.1b) is given by:

$$I = \frac{1}{2} MR^2$$

where  $M$  is the mass of the disk and  $R$  is the radius of the disk. The rotational inertia of a disk about its diameter (Figure 4.1c) is given by:

$$I = \frac{1}{4} MR^2$$

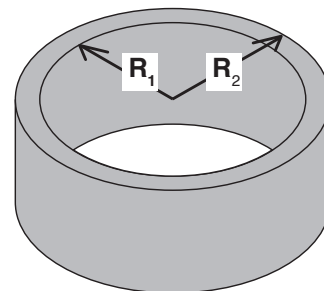

**Figure 4.1a**  
Definition of  $R_1$  and  $R_2$  of a ring

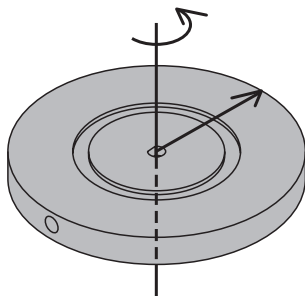

**Figure 4.1b**  
Disk rotating about its center of mass

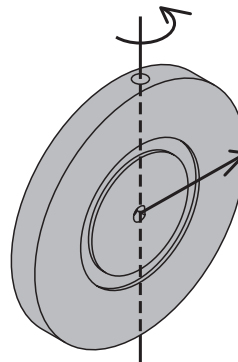

**Figure 4.1c**  
Disk rotating about its diameter

To find the rotational inertia experimentally, a known torque is applied to the object and the resulting angular acceleration is measured. Since  $\tau = I\alpha$ ,

$$I = \frac{\tau}{\alpha}$$

where  $\alpha$  is the angular acceleration, which is equal to  $a/r$ , and  $\tau$  is the torque caused by the weight hanging from the thread that is wrapped around the base of the apparatus.

$$\tau = rT$$

where  $r$  is the radius of the 3-Step Pulley about which the thread is wound and  $T$  is the tension in the thread when the apparatus is rotating.

Applying Newton's Second Law for the hanging mass,  $m$ , gives (See Figure 4.2)

$$\Sigma F = mg - T = ma$$

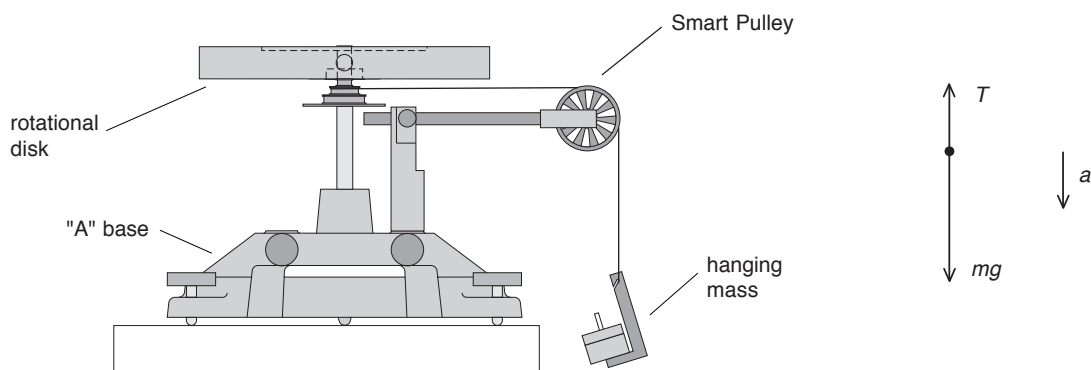

**Figure 4.2**  
Rotational Apparatus and Free-Body Diagram

Solving for the tension in the thread gives:

$$T = m(g - a)$$

Once the linear acceleration of the mass ( $m$ ) is determined, the torque and the angular acceleration can be obtained for the calculation of the rotational inertia.

## Setup

1. Place the disk directly on the center shaft as shown in Figure 4.3. The side of the disk that has the indentation for the ring should be up.
2. Place the ring on the disk, seating it in this indentation.
3. Mount the Smart Pulley to the base and connect it to channel 1 or 2 of the Smart Timer.

## Procedure

### Measurements for the Theoretical Rotational Inertia

1. Weigh the ring and disk to find their masses and record these masses in Table 4.1.
2. Measure the inside and outside diameters of the ring and calculate the radii  $R_1$  and  $R_2$ . Record in Table 4.1.
3. Measure the diameter of the disk and calculate the radius  $R$  and record it in Table 4.1.

**Table 4.1. Theoretical Rotational Inertia Data**

Mass of Ring	
Mass of Disk	
Inner Radius of Ring	
Outer Radius of Ring	
Radius of Disk	

### Accounting for Friction

1. Set up the Smart Timer to measure **Speed, Pulley (rev/s)**.
2. Tie several paper clips onto the string that hangs over the Smart Pulley.
3. Start the disk spinning slowly.
4. Adjust the hanging mass (number of paper clips) until the speed remains constant.
5. Record this “friction mass” in Table 4.2.
6. Repeat for each setup below: ring and disk combined, disk alone, and disk vertical.

### Measurements for Determining the Rotational Inertia Experimentally

1. Set up the Smart Timer to measure **Acceleration, Linear Pulley (cm/s<sup>2</sup>)**.
2. Find the acceleration of the ring and disk using a hanging mass of about 50 g. Wind the thread up and let the mass fall. Record the acceleration (press **3**) when the mass has fallen about 1/3 of the total fall distance (to minimize the effect of friction). Repeat at

- least three times and record the average values for weight of the hanging mass and acceleration in Table 4.2.
3. Using calipers, measure the diameter of the pulley about which the thread is wrapped and calculate the radius.
  4. Since in **step 2**, the disk is rotating as well as the ring, it is necessary to determine the acceleration and the rotational inertia of the disk by itself. This rotational inertia can be subtracted from the total, leaving only the rotational inertia of the ring. To do this, take the ring off the rotational apparatus and repeat **step 2** using a hanging mass of approximately 30 g.
  5. Remove the disk from the shaft and rotate it up on its side. Mount the disk vertically by inserting the shaft in one of the two “D”-shaped holes on the edge of the disk. See Figure 4.4.
  6. Repeat **steps 2** and **3** and record the data in Table 4.2.

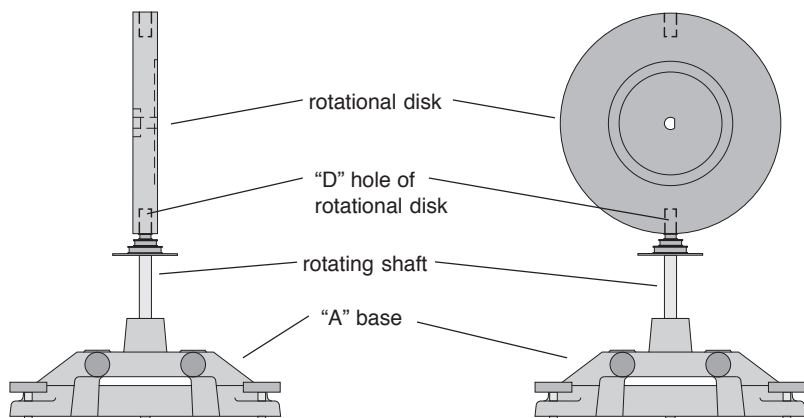

**Figure 4.4**  
Disk mounted vertically

**Table 4.2. Experimental Rotational Inertia Data**

	Ring and Disk Combined	Disk Alone	Disk Vertical
Friction Mass			
Hanging Mass			
Hanging Mass– Friction Mass			
Acceleration (a)			



## Calculations

Record the results of the following calculations in Table 4.3.

1. Subtract the “friction mass” from the hanging mass used to accelerate the apparatus to determine the mass,  $m$ , to be used in the equations.
2. Calculate the experimental value of the rotational inertia of the ring and disk together.
3. Calculate the experimental value of the rotational inertia of the disk alone.
4. Subtract the rotational inertia of the disk from the total rotational inertia of the ring and disk.

*Note:* This calculation will be the rotational inertia of the ring alone.

5. Calculate the experimental value of the rotational inertia of the disk about its diameter.
6. Calculate the theoretical value of the rotational inertia of the ring.
7. Calculate the theoretical value of the rotational inertia of the disk about its center of mass and about its diameter.
8. Use a percent difference to compare the experimental values to the theoretical values.

	Theoretical	Experimental	% Difference
Rotational Inertia for the Ring and Disk Combined			
Rotational Inertia for the Disk Alone			
Rotational Inertia for the Ring			
Rotational Inertia for the Vertical Disk			



## Other Suggested Experiments

*Note: The following experiments are in copy-ready form in the manual for the Dynamics Cart Accessory Track Set (manual number 012-05035)*

- **Acceleration Down an Incline (Experiment 8):**

Use a Photogate and the Smart Timer instead of a stop watch (Figure 5.1). Adjust the height of the Photogate so the light path is intersected with the 5 cm fence of the Smart Timer fences. Set up the Smart Timer to measure **Acceleration, One Gate**. Press **3** to activate the Smart Timer, and release the cart.

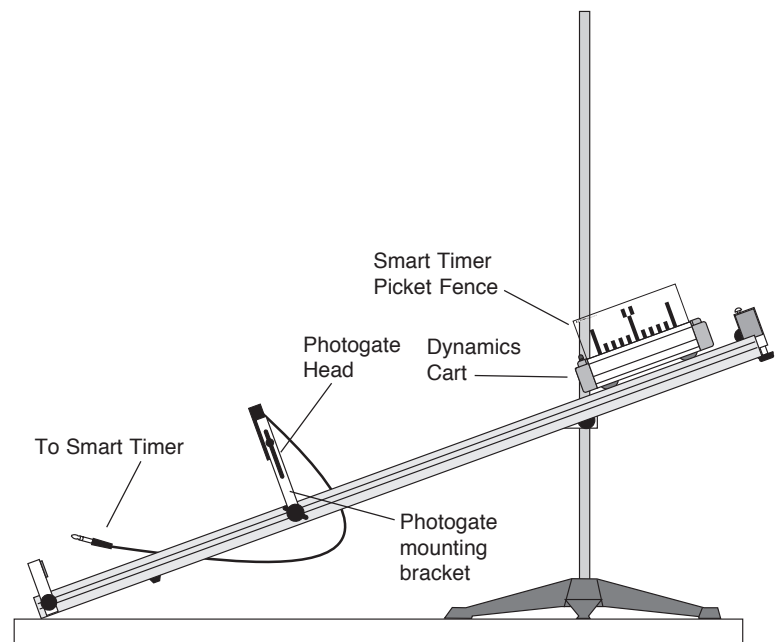
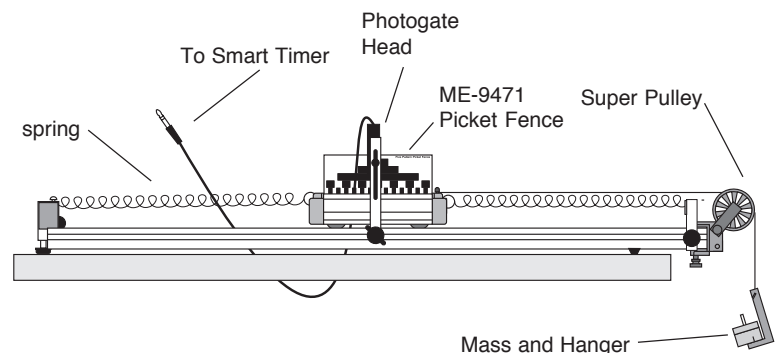

**Figure 5.1**

Setup for the *Acceleration Down an Incline* Experiment

- **Simple Harmonic Oscillator (Experiment 3):**

Use a Photogate and the Smart Timer instead of a stop watch, and use the ME-9471 Picket Fence (part number 648-04704), not the Smart Timer Picket Fence (Figure 6.1). Set up the Smart Timer to measure **Time, Pendulum**. Press **3** to activate the Smart Timer to measure the period of oscillation.

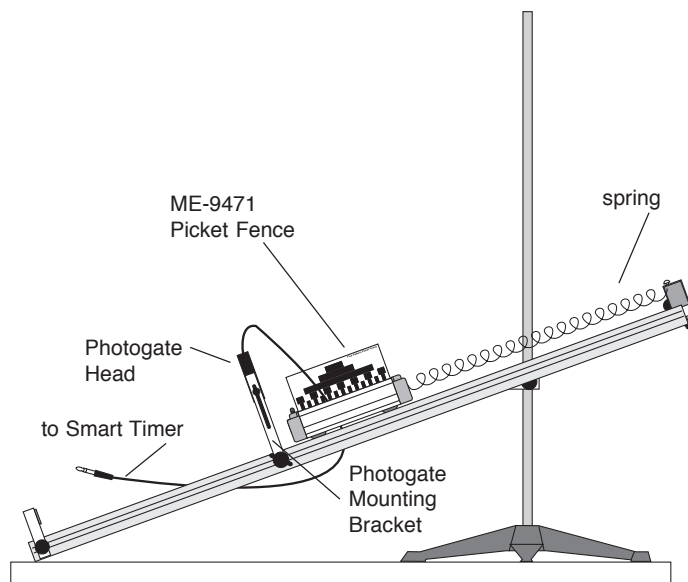

**Figure 6.1**

Setup for the *Simple Harmonic Oscillator* Experiment

- **Oscillations on an Incline (Experiment 4):**

Use a photogate and the Smart Timer instead of a stop watch, and use the ME-9471 Picket Fence (part number 648-04704), not the Smart Timer Picket Fence (Figure 7.1). Set up the Smart Timer to measure **Time, Pendulum**. Start the cart oscillations, and Press **3** activate the Smart Timer to measure the period of oscillation.



**Figure 7.1**  
Setup for the *Oscillations on an Incline* Experiment

- **Springs in Series and Parallel (Experiment 5):**

Use the setup illustrated in Figure 7.1. Set up the Smart Timer to measure **Time, Pendulum**. Start the cart oscillations, and activate the Smart Timer to measure the period of oscillation.

*Note: The following experiment is in copy-ready form in the manual for the Introductory Dynamics System with Computer Timing Kit (manual number 012-04894)*

- **Conservation of Energy (Experiment 8):**

Use a Photogate and the Smart Timer instead of a computer and IDS Timer software, and set the experiment up as directed in the experiment. Set up the Smart Timer to measure **Speed, One Gate**. To measure the velocity of the cart, activate the Smart Timer and before releasing the plunger of the Dynamics Cart.

*Note: The following experiment is in copy-ready form in the manuals for the Mini Launcher (manual number 012-05479) and the Ballistic Pendulum/Projectile Launcher (manual number 012-05375)*

• **Projectile Motion Using Photogates (Experiment 2):**

Use the Smart Timer instead of a computer and IDS Timer software, and set the experiment up as directed in the experiment. Plug the photogates into the Smart Timer as shown in Figure 8.1, and set up the Smart Timer to measure **Time, Two Gates**. Press **3** to activate the Smart Timer and fire the launcher. Calculate the initial velocity using the time required for the ball to pass through the photogates.

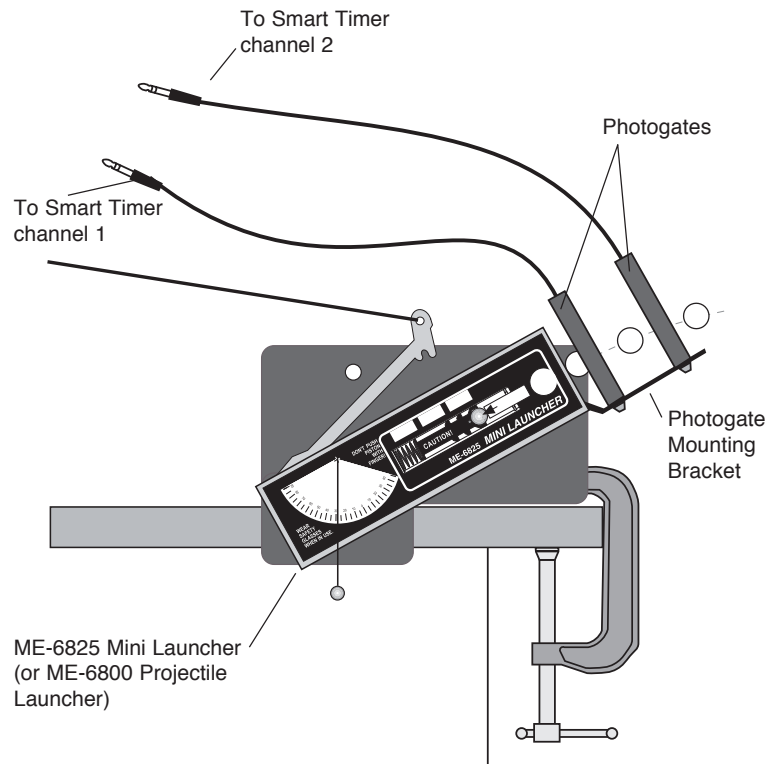

**Figure 8.1**

Setup for the *Projectile Motion Using Photogates* Experiment

*Note: The following experiment is in copy-ready form in the manual for the Time of Flight Accessory (manual number 012-05088)*

• **Time of Flight and Initial Velocity (Experiment 1):**

Use the Smart Timer instead of a Photogate Timer, and set the Smart Timer to measure **Time, Two Gates**. Be sure the plug from the Photogate is connected to channel 1 of the Smart Timer and the plug from the Time of Flight Accessory is connected to channel 2 (see Figure 9.1). Press **3** to activate the Smart Timer and fire the launcher.

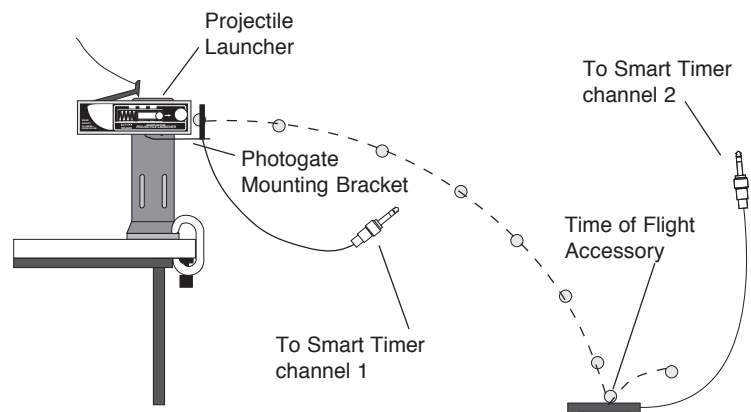
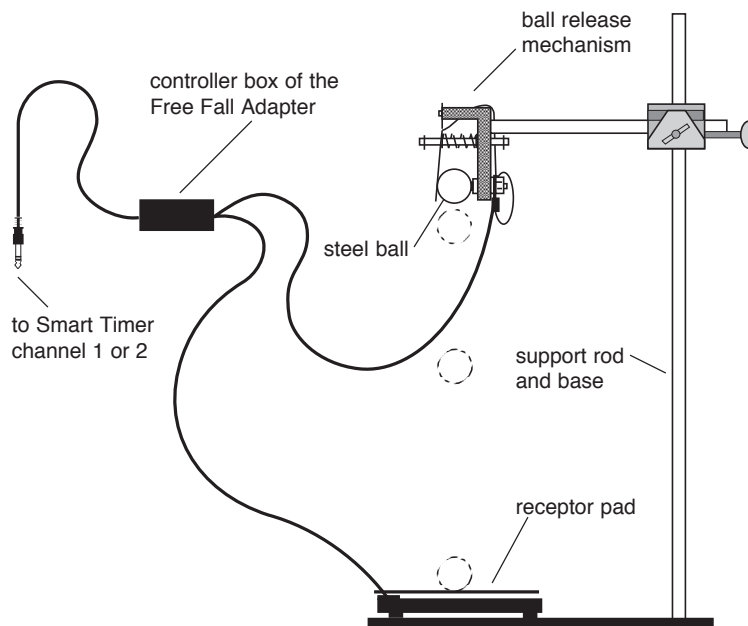

**Figure 9.1**

Setup for the *Time of Flight and Initial Velocity* Experiment

- **Determining the acceleration due to gravity ( $g$ ) with the Free Fall Adapter (ME-9207B)**

Insert the plug of the Free Fall Adapter into channel 1 or 2 of the Smart Timer (Figure 10.1) Set up the **Stopwatch** mode of the Smart Timer. Press **3** once. The Smart Timer is now activated and will record the time the interval between the release of the ball and the contact of the ball with the receptor pad of the Free Fall Adapter.

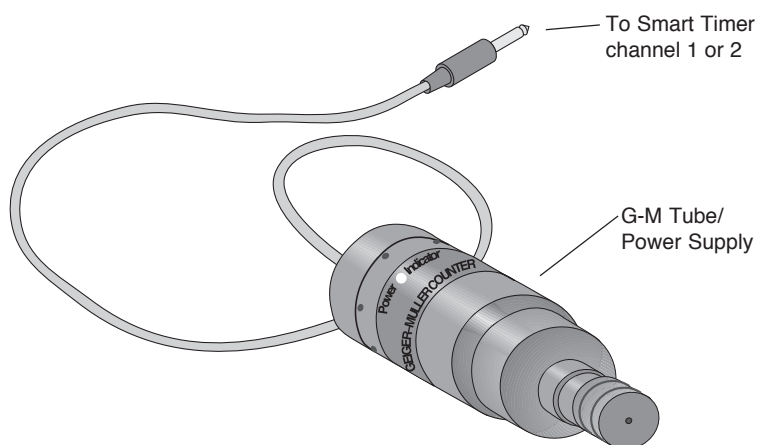

**Figure 10.1**

Setup for determining the acceleration due to gravity with the ME-9207B Free Fall Adapter.

- **Counting radiation with the G-M Tube/Power Supply (SN-7927)**

Insert the plug of the G-M Tube/Power Supply into channel 1 or 2 of the Smart Timer (Figure 11.1) Set up the Smart Timer to measure **Counts, 30 seconds, 60 seconds, 5 minutes, or Manual**. Press **3** to activate the Smart Timer.



**Figure 11.1**

Setup for counting radiation with the SN-7927 G-M Tube/Power Supply

# Technical Support

## Feedback

If you have any comments about the product or manual, please let us know. If you have any suggestions on alternate experiments or find a problem in the manual, please tell us. PASCO appreciates any customer feedback. Your input helps us evaluate and improve our product.

## To Reach PASCO

For technical support, call us at 1-800-772-8700 (toll-free within the U.S.) or (916) 786-3800.

fax: (916) 786-3292

e-mail: [techsupp@pasco.com](mailto:techsupp@pasco.com)

web: [www.pasco.com](http://www.pasco.com)

## Contacting Technical Support

Before you call the PASCO Technical Support staff, it would be helpful to prepare the following information:

- ▶ If your problem is with the PASCO apparatus, note:
  - Title and model number (usually listed on the label);
  - Approximate age of apparatus;
  - A detailed description of the problem/sequence of events (in case you can't call PASCO right away, you won't lose valuable data);
  - If possible, have the apparatus within reach when calling to facilitate description of individual parts.
- ▶ If your problem relates to the instruction manual, note:
  - Part number and revision (listed by month and year on the front cover);
  - Have the manual at hand to discuss your questions.

