

Motion Sensor

Included Equipment

Motion Sensor

Additional Equipment Required

PASPORT-compatible Interface

Quick Start

1. Connect the Motion Sensor to your PASPORT-compatible interface (such as the 850 Universal Interface or the SPARK Science Learning System).
2. If you are using a computer, connect the PASCO interface to it and start the data acquisition software (such as PASCO Capstone or SPARKvue).
3. Place an object in front of the sensor at least 15 cm away.
4. Click "Record" or press "Start" to begin recording data.
5. Move the object in a straight line directly away from or toward the sensor.

Introduction

The Motion Sensor works with your PASCO interface to measure and record position, velocity, and acceleration. It produces a series of ultrasonic pulses and detects the sound reflecting back from an object in front of it. The interface measures the times between outgoing pulses and returning echoes. From these measurements, it determines the position, velocity, and acceleration of the object.

This instruction sheet includes procedures for setting up the hardware and software collecting data, changing the sample rate, calibrating the sensor, mounting the sensor on equipment, and troubleshooting.

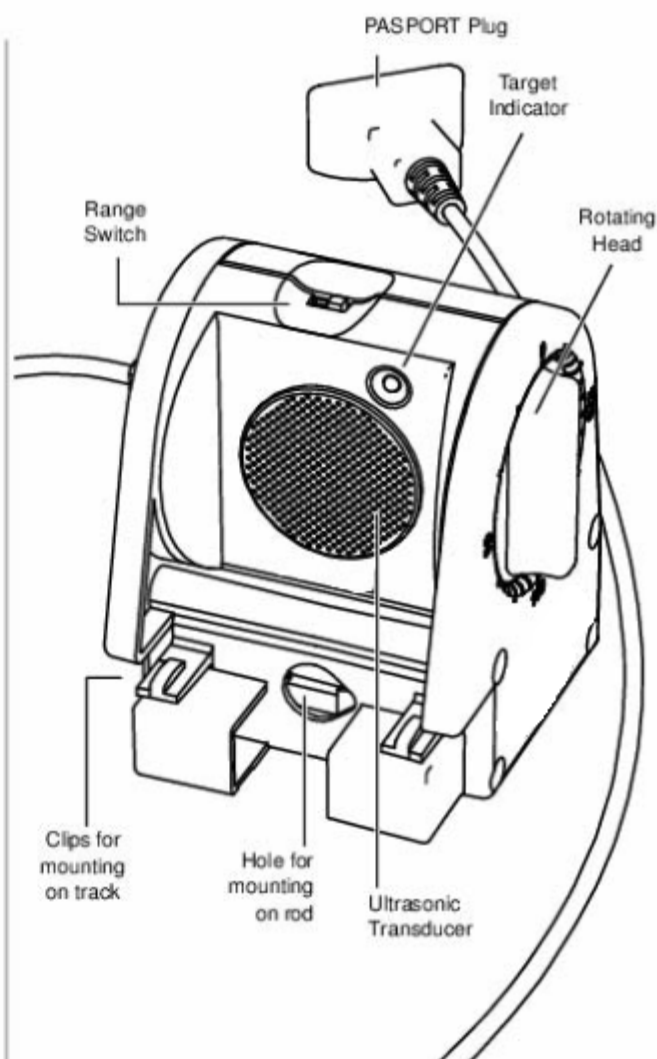

Theory of operation is described and specifications are listed at the end of these instructions.

Set-up

To Connect to a PASPORT-compatible Interface

1. Connect the Motion Sensor's plug to a PASPORT input port of your PASCO interface.

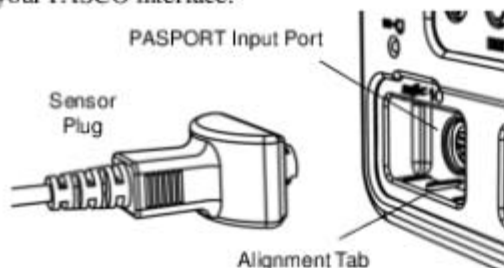

2. Turn on the interface. If you are using a computer, connect the interface to it and start the data acquisition software.

PASCO Capstone

- PASCO Capstone will automatically prepare itself for data collection. In the software, click the "Hardware Setup" icon in the Tools palette to open the Hardware Setup panel.



- Confirm that the panel shows the icon of the Motion Sensor connected to the icon of the interface.
- To create a graph display, double click a choice in the workbook page, or drag the Graph icon from the Displays palette to the workbook page.

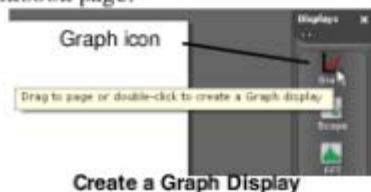

SPARK Science Learning System (SLS)

- When the sensor is connected to a SPARK SLS, the screen shows a list of the sensor's parameters (such as position, velocity, and acceleration).
- Press a measurements and then press the "Show" icon to create a graph display.

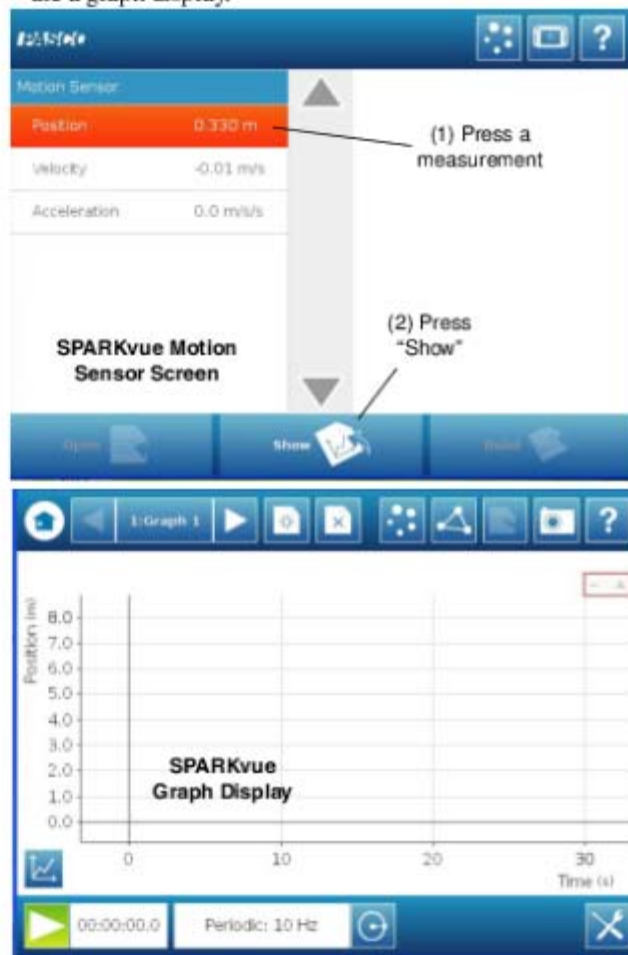



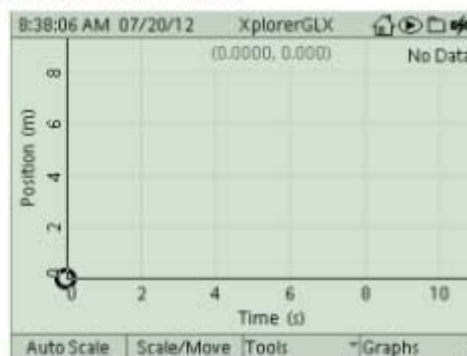

Xplorer GLX

- The Xplorer GLX automatically detects the Motion Sensor and opens a graph display of position on the vertical axis and time on the horizontal axis.



To Aim the Motion Sensor at an Object

- Set the range switch to the short range () or long range () setting.
 - Select  for measuring a cart on a track.
 - Select  for measuring most other objects.
- Arrange the Motion Sensor and object so that the Motion Sensor's transducer faces the object.
 - The object should be at least 15 cm from the transducer.
 - If the object will move, it should move directly toward or away from the Motion Sensor.
 - Aim the motion sensor slightly up to avoid detecting the tabletop.

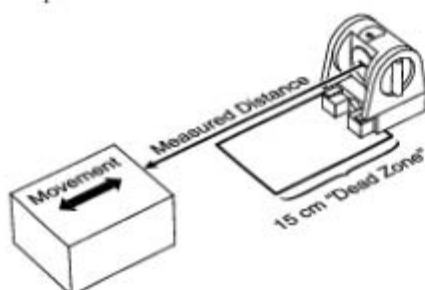

- Remove objects that may interfere with the measurement. These include objects between the sensor and target object, either directly in front of the sensor or to the sides.

Data Collection

PASCO Capstone

- Click **Record**.

The Motion Sensor starts clicking. If a target is in range, the target indicator flashes with each click. PASCO Capstone starts collecting and displaying data.

- Click **Stop** to stop data collection.



SPARK SLS

- Press **Start** to begin collecting and recording data.
- Press **Stop** to end data collection.

Xplorer GLX (Standalone)

- Press .

The Motion Sensor starts clicking. If a target is in range, the target indicator flashes with each click. The GLX starts collecting and displaying data.

- Click  to stop data collection.
- Click  again to start recording data in a new data run.

Sensor Configuration

To View Velocity and Acceleration

The Position measurement appears by default. You can also enable Velocity and Acceleration measurements.

- In the PASCO Capstone graph, click the label of the vertical axis and select **Velocity** or **Acceleration** from the Measurements Menu.
- In the SPARKvue graph, press the Graph Tools icon to open the Graph Tools palette. Press the Display Properties icon to open the Line Graph Properties screen. Press **Velocity** or **Acceleration** and then press **OK**.

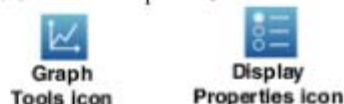

- On the GLX while viewing any display screen, press  twice to open a data source menu. Select **More** to expand the menu. Select **Velocity** or **Acceleration**.





To Change the Sample Rate

- In PASCO Capstone, change the Motion Sensor sampling rate by clicking the up or down arrows in the Sample Rate Control tool.



- In SPARKvue, press the Sampling Options icon. Select the Sampling Mode, Sample Rate, and Sample Rate Unit in the Sampling Options screen, and then press **OK**.



- On the GLX, press  +  to open the Sensors screen. Highlight the **Sample Rate** setting and press  or .

The normal range of sampling rates is between 1 Hz and 50 Hz. At the default rate, the Motion Sensor can measure distance up to 8 m. The maximum distance decreases with increasing sample rate. At very high sample rates (between 50 Hz and 250 Hz), the maximum distance is less than 2 m.

Equipment Mounting

Mount the Motion Sensor as illustrated on a vertical rod (a) or a horizontal rod (b).

Integrated clips allow it to be attached to the end of a dynamics track (c).

A threaded hole in the bottom of the unit (d) is provided for attachment to the PS-2546 Magnetic Bracket (e), the ME-6743 Cart Adapter (f), and other 1/4-20 threaded mounting devices such as a camera tripod.

To protect the Motion Sensor from being hit by an object, use a device such as the SE-7256 Motion Sensor Guard (g) or ME-9806 bracket with a rubber band (h). The Motion Sensor can "see through" a wire screen or rubber band placed close to the transducer.

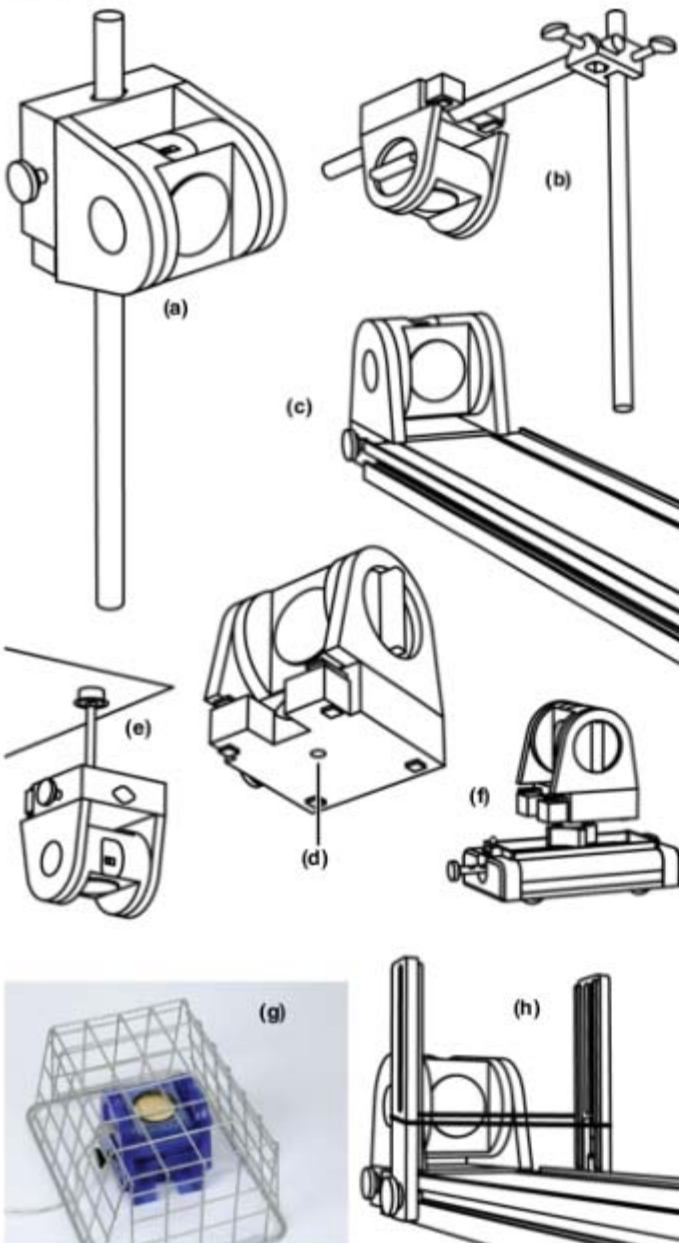

Troubleshooting

If the Motion Sensor fails to perform satisfactorily, try these steps:

- Ensure that the target object is no closer than 15 cm.
- Switch the range switch to the other setting.
- Adjust the aim left, right, up, or down. In some cases the Motion Sensor works best when it is aimed slightly to the side or above the target in order to exclude interfering objects.
- Improve the target by adding a larger or harder surface to reflect ultrasound. A small object can be a better reflector than large object if it has a harder surface.
- Remove interfering objects near the target object or sensor.
- Increase or decrease the sample rate.

Theory of Operation

The Motion Sensor uses an electrostatic transducer as both a speaker and a microphone. For each sample, the transducer transmits a burst of 16 ultrasonic pulses with a frequency of about 49 kHz. This burst of pulses can be heard as a single click. The ultrasonic pulses reflect off an object and return to the sensor. The target indicator on the sensor flashes when the transducer detects an echo.

Sound intensity decreases with distance; to compensate, the sensor increases the gain of the receiver amplifier as it waits for the echo. The increased gain allows the sensor to detect an object up to 8 m away. The lower gain at the beginning of the cycle reduces the circuit's sensitivity to echoes from false targets.

The sensor measures the time between the trigger rising edge and the echo rising edge. It uses this time and the speed of sound to calculate the distance to the object. To determine velocity, it uses consecutive position measurements to calculate the rate of change of position. Similarly, it determines acceleration using consecutive velocity measurements.

Specifications

Minimum Range	15 cm
Maximum Range	8 m
Transducer Rotation	360°
Range Settings	Short Range: for distance measurement up to 2 m with improved rejection of false target signals and air-track noise Long Range: for distance measurement up to 8 m
Mounting Options	<ul style="list-style-type: none">• On rod up to 12.7 mm diameter• Directly to PASCO dynamics tracks• On table top

The European Union WEEE (Waste Electronic and Electrical Equipment) symbol (to the right) and on the product or its packaging indicates that this product **must not** be disposed of in a standard waste container.

