

Electricité

Electrostatique

Electricity

Electrostatics

**Ref :
272 008**

Français – p 1

English – p 13

Version : 9003

Kit électrostatique

Electrostatic kit

1 The kit consists of (patented product)

- A piezoelectric generator
- A multi-function support
- A luciole light, a neon gas light, a transparent high luminosity diode
- Three rods including two plastic (red, fluo green), and one metal ($\varnothing = 6$ mm, $L \cong 150$ mm)
- Two translucent plastic tubes, ($\varnothing = 12$ mm, $L \cong 75$ mm)
- One transparent plastic insert ($L = 9,2$ cm, $L \cong 136$ mm)
- One steel rod and one stand ($\varnothing = 1$ mm, $L \cong 150$ mm)
- A piece of plasticine
- A metre of self adhesive aluminium and four terminals (2 Red, 2 Green)
- Two profiled, drilled plates

2 Experiments

2.1 Making a charge detector

The students construct an electric pendulum. Take a length of about 30 cm of cotton thread, or, better still, nylon (8/100ths) and fix a small tip of adhesive aluminium to one of its ends.

2.2 Exploring the distribution of charges

❖ The case of an insulating charge

By rubbing with wool or a similar fabric, the green fluo rod becomes electrically charged positively, the red negatively (according to the fabric, the charge developed can be the opposite in the same rod).

Only rub one end, put the rod on the translucent tube, using a small blob of plasticine. Move the pendulum around the rod; you will see the asymmetry in the distribution of the charge.

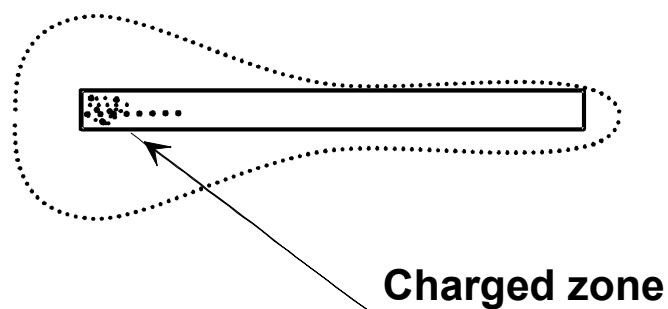
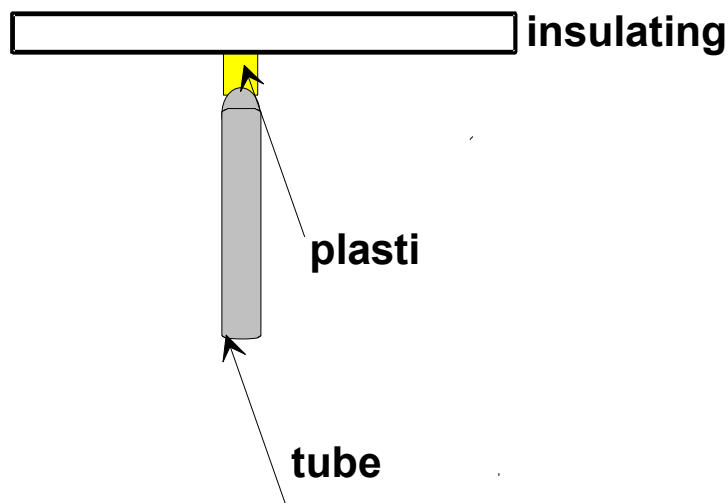

Case of a plastic tube

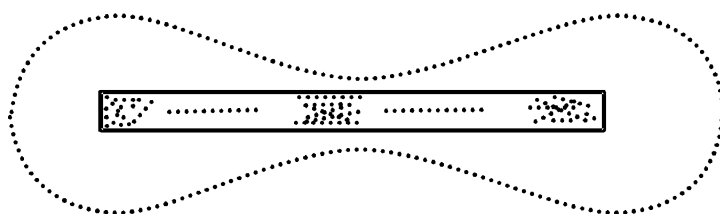

Case of a conducting tube

❖ Case of a charged conductor.

By contact at an extremity, charge the metal rod with a charged insulator. The pendulum reveals the distribution of the charges on the conductor and the symmetry.

You can use one of the terminals of the piezo generator to charge the conductor by contact.

2.3 Interactions between coloured rods and between rods and the object to test.

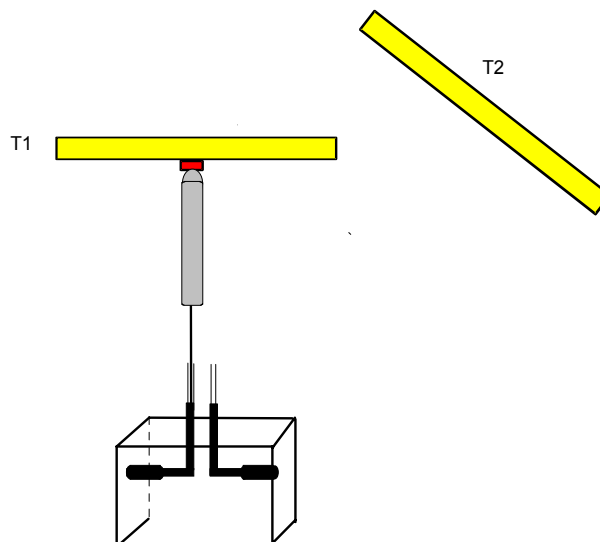

- The previous device is made to rotate by putting it on the steel rod. This is put into one of the multi-function support springs.

Electrify an extremity of each rod. Approach T2, there is an attraction.

Hold T2 in your hand, vertically and make it turn around the axis, you start T1 rotating.

- Without changing T1, you can approach plastic objects electrified by rubbing and determine the nature of the charges (ball point pen, ruler, etc.).
- If you approach your finger with the electrified end, there is still an attraction (charge by induction).

2.4 Electric pendulum and coloured rods.

The stand is put into one of the multi-function support springs.

The length of the pendulum is adjusted using the plasticine.

Approach one electrified coloured rod, observe the attraction of the pendulum then its repulsion.

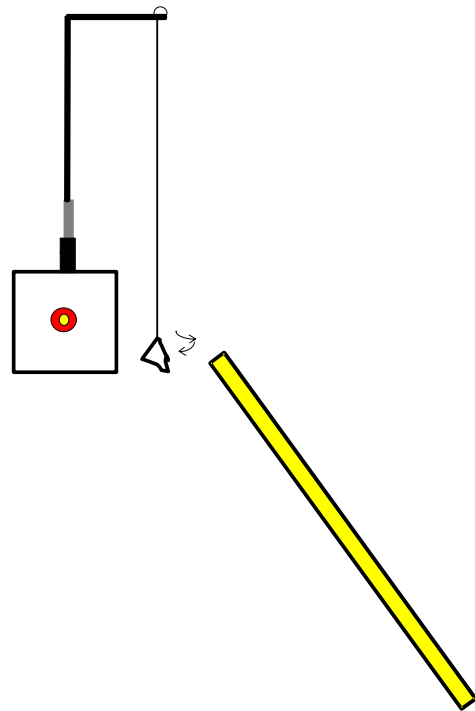

2.5 Piezoelectric generator

Avoid using the piezoelectric generator in open circuit, this operation risks damaging the piezoelectric ceramics.

In open circuit the generator supplies a variable voltage of about 15 KV, it can be short circuited without risk of damage.

❖ Determining the signs of the terminals

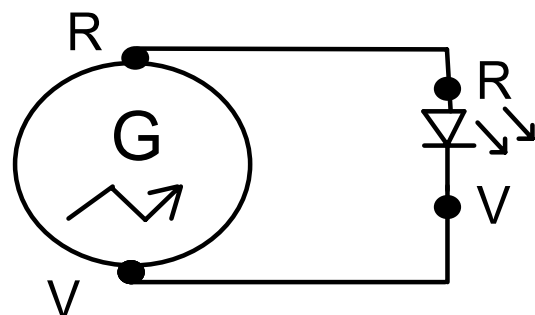

- **with the luminous diode**

Connect the generator to the multi-function support (R, R, V, V) and the diode fitted as in the diagram. Each pin in a spring.

If you hold the button down, the diode lights, the red terminal is then positive.

If, on the contrary, on releasing the button the diode lights, the red terminal is then negative and the green positive.

- **with the neon gas light**

In a neon lamp, light is emitted at the negative terminal.

After putting each of the lamp's pins in a spring, you make a cycle, the electrodes light up by turns.

From this you conclude that the generator is an alternating generator.

❖ **Sparks**

• **Between the springs**

Connect the generator directly to the multi-function support. By pressing, you obtain a stream of sparks in one direction. On releasing the button, a second series of sparks is obtained. They tend to be produced at the top (point effect), or at the base (shortest distance).

❖ **Transparent insert on lightening**

This device calls for creativity and reflection by the student.

On first assembly, get the students to cut out two strips of aluminium in the profile shown below.

They are stuck one each side of the four feet.

The sleeves, on the other hand, which are used to puncture the aluminium at the places planned, are put on one side or the other, as need be. The aluminium is pushed into the holes where electrical contact is made with the metal part of the sleeve.

Profile of the aluminium strip

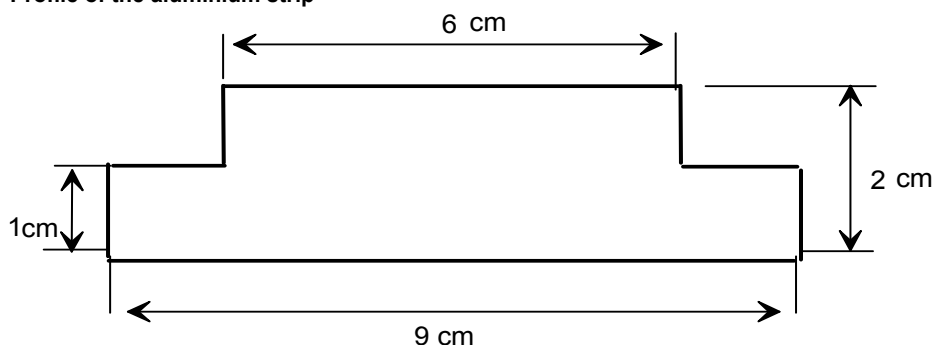

❖ **Operation**

a) On one side, make a first scene with, for example, a cloud, a tree, a person.

The condition for sparks is given: the sum of the distances between the metal objects should not exceed about 1 cm.

b) Add parallel paths, the objects can have advanced effects.

c) Copy the scene, putting a 9 x 9 cm paper square on the insert that you turn towards the light. The contours appear, draw it to scale 1. Sparks are represented by segments between the different elements. You make the sum of these segments which should satisfy conditions for sparking.

d) If you have 2 to 3 possible parallel paths, it is an advantage. You can vary the conditions by putting a pin on the scene and observing the alterations.

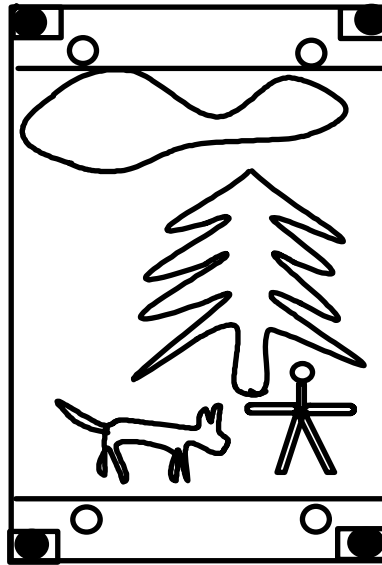

2.6 Turbine, Generator, multi-function support.

Students can each construct their own turbine. From the self adhesive aluminium cut out a strip to approximate size (1 cm x 8 cm). At the extremities, stick two points in aluminium of 1.5 cm x 0.5 cm. Pierce at the centre, to introduce the rivet.

The rivet is put at the top of the steel stem T which has been put in one of the springs of the multi-function support. One wire is connected to the turbine. The other is put near the support for better effectiveness.

By regular, slow action on the generator button, the turbine is made to rotate (2 to 3 revs/sec).

If the turbine is distorted to make it spiral in shape, the rotation is slowed.

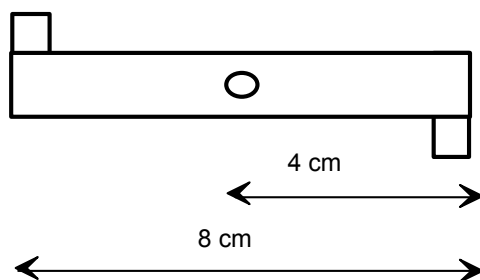

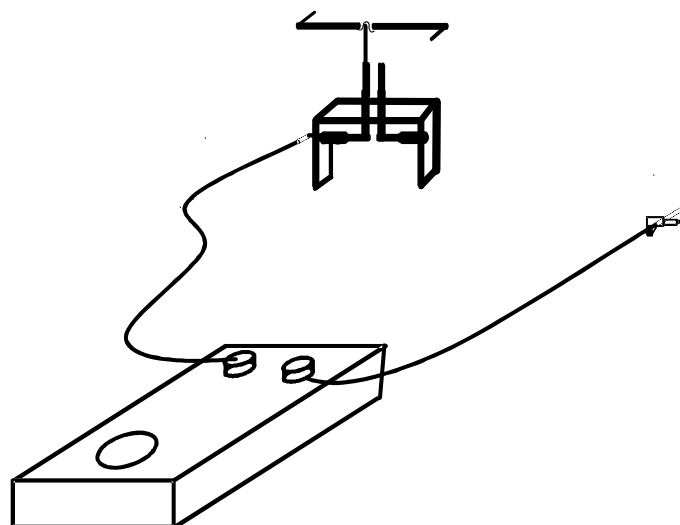

Comment: a particularly spectacular experiment consists of putting two inverse turbines fairly close < 1 cm. You get sparks in addition to reversed rotations.

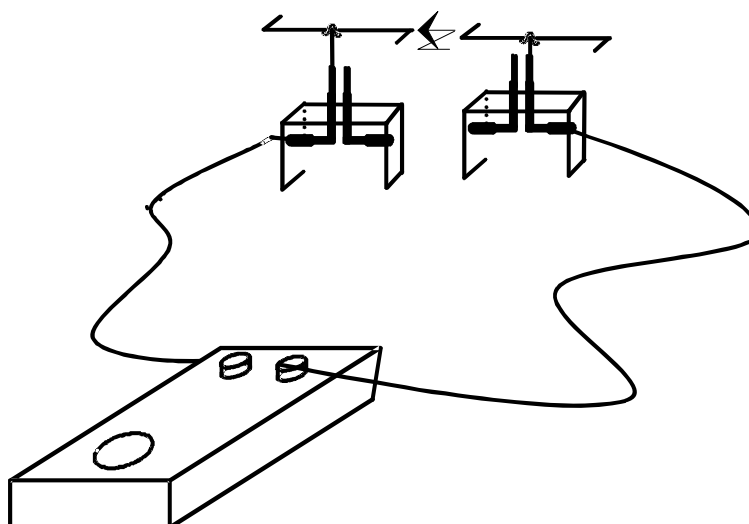

2.7 Generator, multi-function support, lamps.

- An analysis of series and parallel circuits fed by the generator and using gas tubes, incandescent bulbs and diodes can be undertaken. A multi-function support will be seen as an open switch, which closes automatically when there is a spark. Ohm's general law enables these phenomena to be described.

- It is interesting to see that by pressing regularly, you always supply the same mechanical energy.

In the circuit, on the other hand, electrical energy can be distributed at differing intervals of time. You have varying power available.

Particularly, an incandescent bulb fitted alone on the generator cannot be lighted. Fitted in series with a multi-function support the filament can be made to glow.

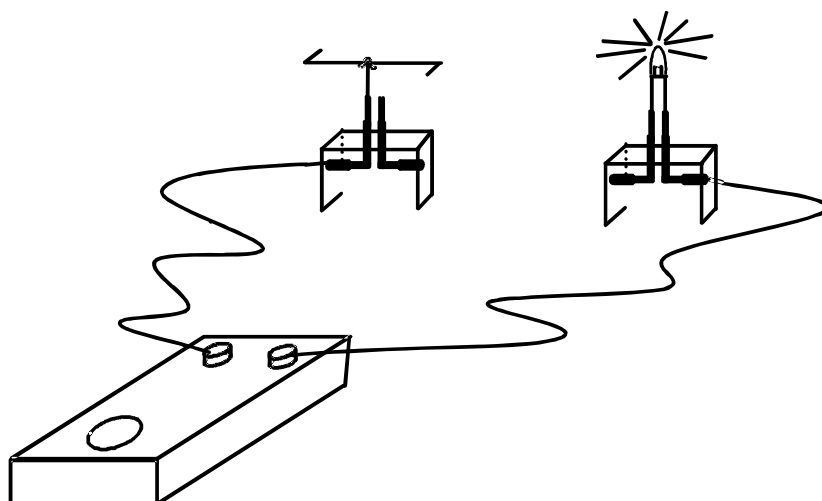

2.8 Generator, multi-function support, rocket

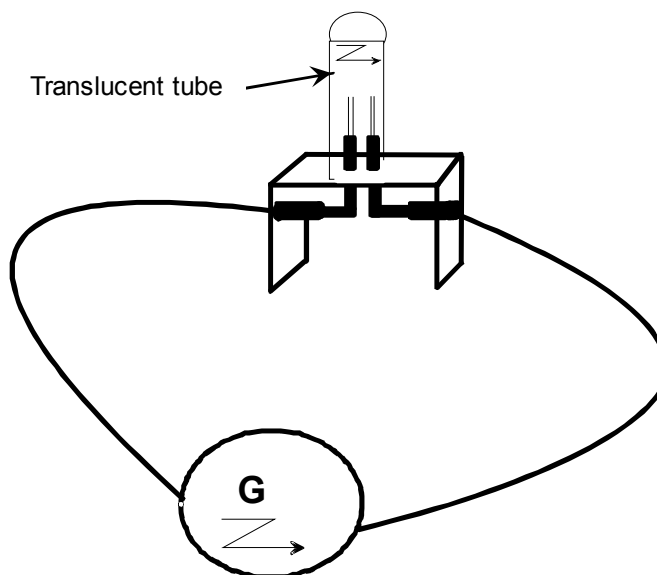

A tube of about 5 ml in unbreakable plastic is filled with a stoichiometric mixture of hydrogen and oxygen (see electrolysis tank). Put it on a multi-function support, the mixture reacts to a spark.

WARNING: The tube is thrown between 1 m and 2 m.

2.9 Generator, electric pendulum, profiled plates.

The profiled plates fix onto the multi-function support by means of the wire connection jacks.

The electric pendulum is put into one of the springs. A plastic tube is placed on the second to avoid sparking between springs.

Operating the generator button causes it to oscillate between the plates.

You can study the influence of the dimensions of the aluminium ball on the number of oscillations. It is an advantage to have a pendulum large and heavy enough (fairly short discharge). Too light a pendulum will leave the plates.

Comment: You can fit the pendulum and the neon tube in series if the pendulum is sufficiently big, you will see the sparks on the tube's electrodes which corresponds to contact of the pendulum on the plates.

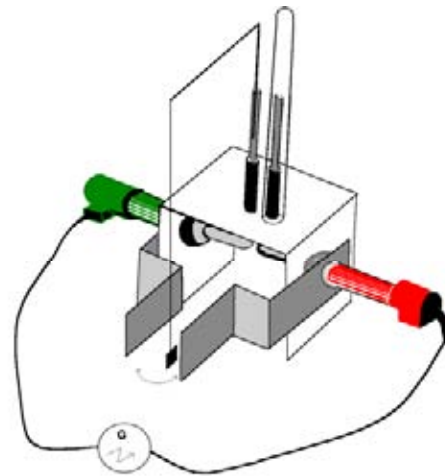

3 Electrolysis mini tank - Rocket

The following experiments require the use of:

Mini voltmeter - Mini-rocket

❖ **Experiments**

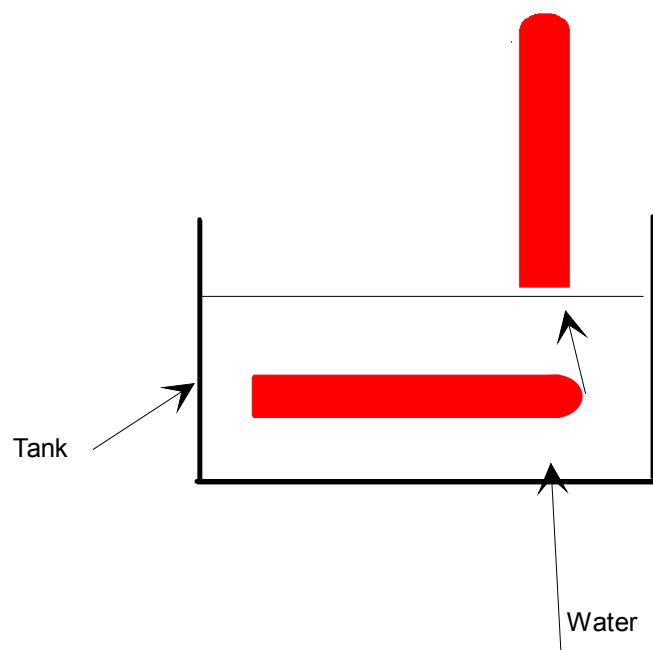

❖ **Electrolysis of water**

- Fill the tank with about 10 ml of water, which is twice the transparent tube
- Supply the mini voltmeter with 6 V or 12 V or use a flat type 4.5 V battery.
- Add 1 ml of sulphuric acid solution.
- Acid leaves no deposit, unlike sodium solutions.
- Fill the tubes in the container and remove them vertically, in this case the water remains in the tube through atmospheric pressure. If you tilt them, they will empty.
- Cover the electrodes with the tubes. The hydrogen and the oxygen are collected separately.

❖ **Rocket, Stoichiometric mixture.**

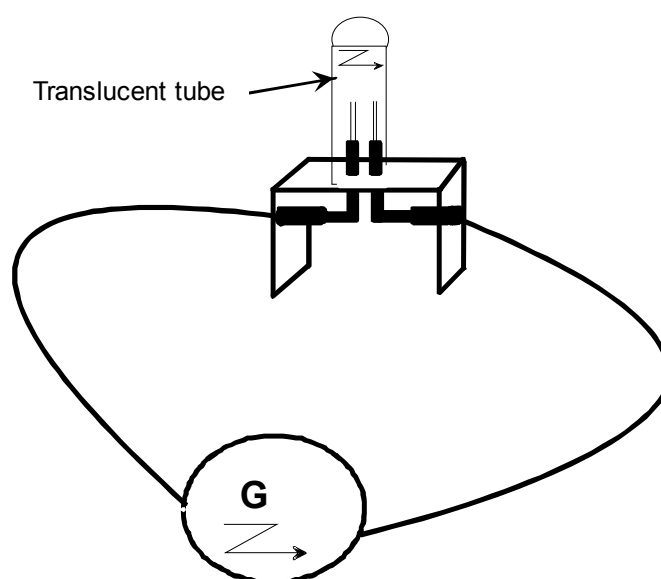

- Proceed as previously, but use the translucent tube, covering the two electrodes.
- Once filling is complete, remove the tube vertically, eliminate any water which may remain at the tube opening with absorbent paper.
- Put the tube on the multi-function support connected to the piezoelectric generator. The spark triggers the chemical reaction. If the experiment is repeated several times in succession, moisture, which is deposited on the springs and support, no longer allows sparking. Wipe with absorbent paper.

Advantages

The mini tank enables:

- A saving in time: the solution is relatively concentrated and the volumes collected (~5 ml) are enough for experiments.
- A saving in product of about 1 ml of sulphuric acid solution.
- Classic electrolysis.
- The production of a mini rocket by means of the multi-function support and spark generator.